

Nähmaschinen-Ersatzteile

Sewingmachine Spare parts

Piezas de recambio para máquinas de coser

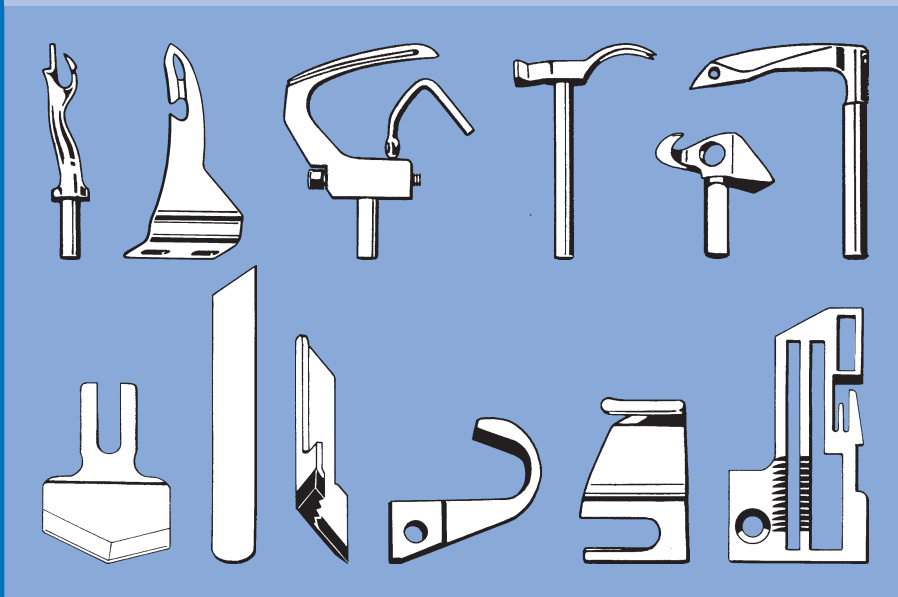
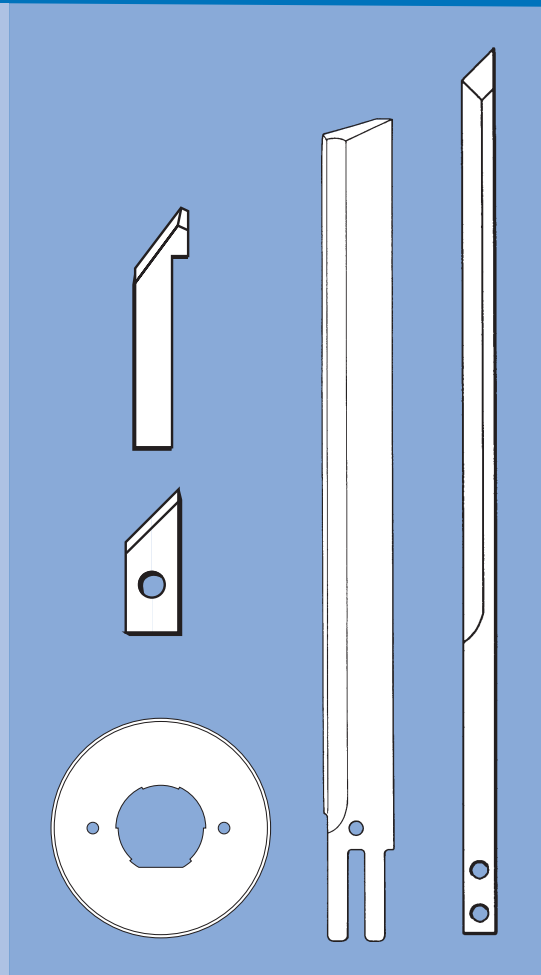

**2013**



**8516**



81077009 (CT)

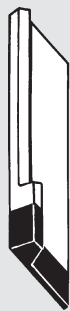

81077012 (CT)



81071606



81071614

**Weitere Messer und Greifer für  
Textima/Altin auf Anfrage.**

**Further knives and looper for  
Textima/Altin on request.**

**Otras cuchillas y anclas para  
Textima/Altin de ser demandadas.**

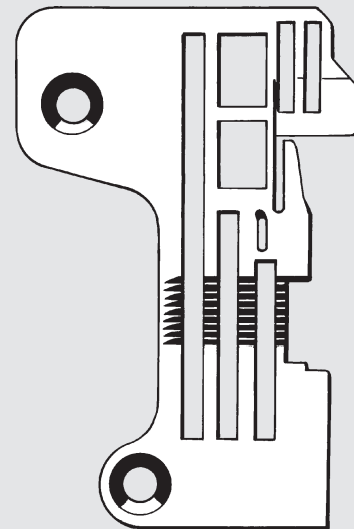

81073087

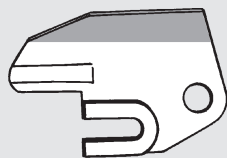

81074018 (CT)



81071415



81071401

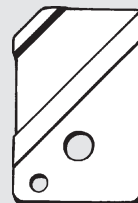

81071609

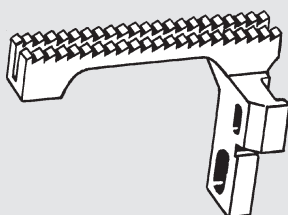

81073371

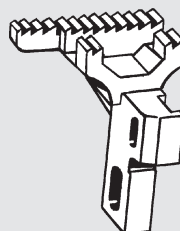

81073034

**8515**

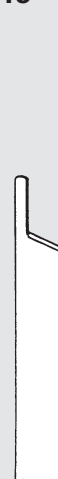

81001127  
81000669  
8509-7.10

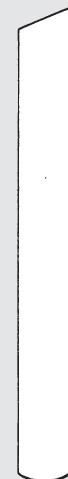

81001126  
81000670  
8509-8.3



**FD4-B 270 Series  
FD4-B 2700 Series**

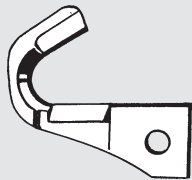

S 09094-001 (CT)

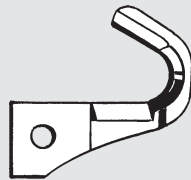

S 09093-001 (CT)

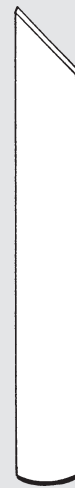

S 09075-001



S 09101-001

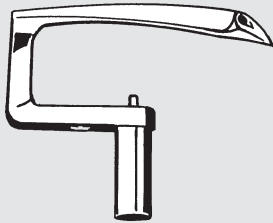

S 08913-001

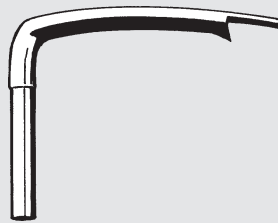

S 08934-001

**B 281**



S 12842-001



S 12865-001

**LK3-B 430, B 433, B 434, B 441, BE 438C,  
KE-430C-436C, KE 484C, KE 438D, KM-4300**

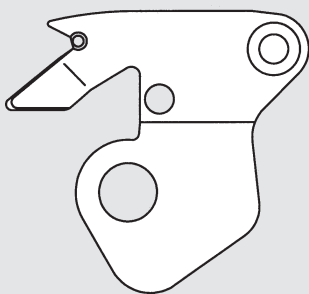

152901-001

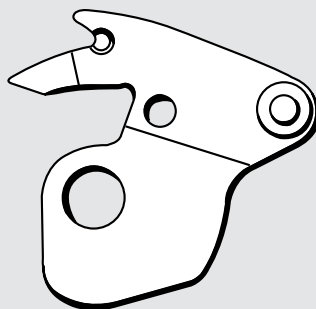

154176-001

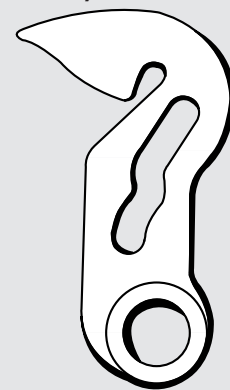

152906-001

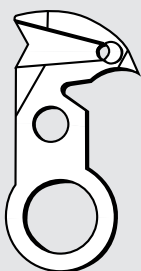

S 49988-001



S 10205-001



SA 6596-001  
SA 3330-001



S 10210-001  
S 10210-201



152905-001

**BAS 310, 311, 326, 342  
BAS 430, 433**



**BAS 320, 322**



S 02375-001

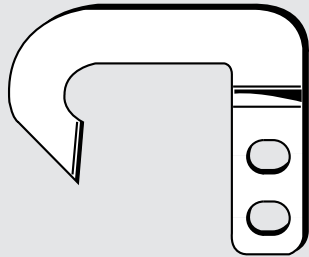

S 02374-001

**B 484**

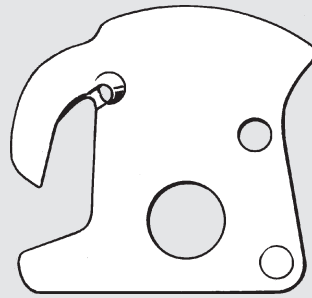

S 00706-201



S 00713-001

**B 711, B 737, B 738, B 791, B 798  
BAS 760**



159540-001

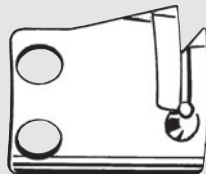

159915-001

**S 6200 A  
S 7200 A**

**S 7200 B  
S 7200 C**

**SL 7220 B  
SL 737, SL 7200 A, SL 7200 B**

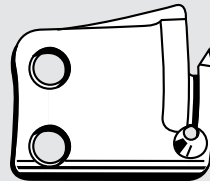

159799-001

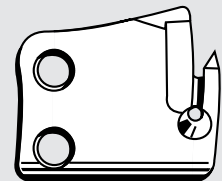

159541-001

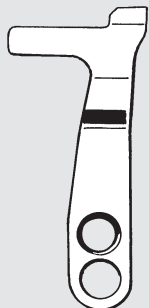

S 02637-001  
S 02637-101

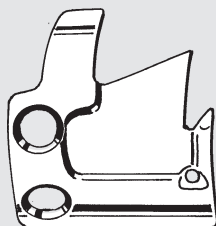

S 02645-001

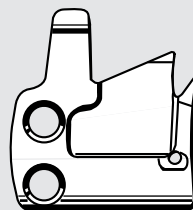

S 02646-001

**DB2-B 716**



154568-001

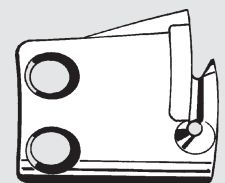

154575-001



**B 600, B 832, B 833, B 837  
BAS 620**

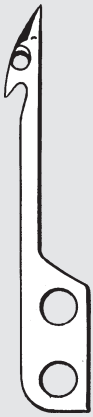

159365-001



153019-001



S 16248-101

**DBZ-B 755**

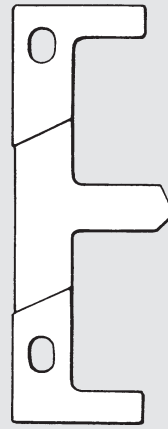

142061-001

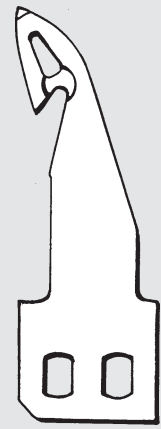

142058-001

**DB 2-B 772  
BAS 423  
SL 777 B**

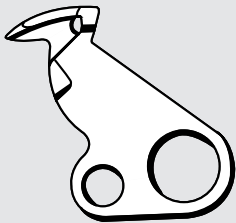

S 32474-001

**SL 777 A, SL 778 A  
SN 771 A, SN 772 A**



S 32477-001



S 10605-001



S 10605-201

**DT 6-B 924, B 928**

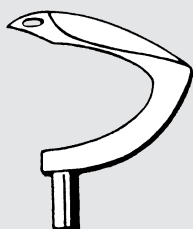

SY 0069084

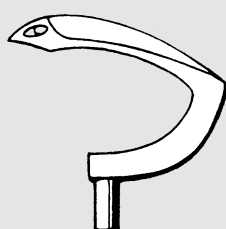

SY 0069085



SY 0069086

**B 931, B 932  
JC-9330, JC-9331  
JC-9380, JC-9381**



110121-001

**LS 5-P 73/P 81**



S 27634-001



LH 4-B 812, B 814, B 815, B 816, B 860, B 800 E  
HE-8000, HM-8180, HE-800 A  
= Singer Kl. 71

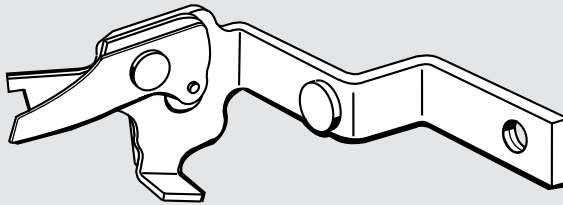

S 50404-401



S 50259-101

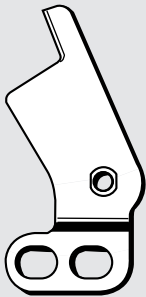

S 50260-101



S 50263-001

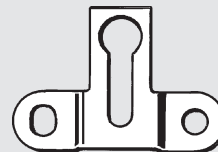

141543-001

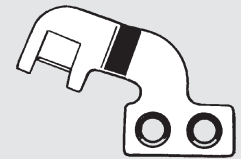

141541-001

**HSS =**  
**High speed steel**  
**Acero rápido de alto**  
**rendimiento**

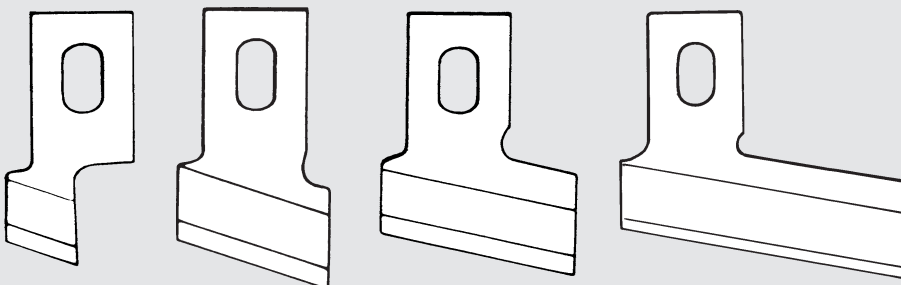

71 1/8	71 13/16
71 1/4	71 7/8
71 5/16	71 15/16
71 3/8	71 1
71 7/16	71 1 1/16
71 1/2	71 1 1/8
71 9/16	71 1 3/16
71 5/8	71 1 1/4
71 11/16	71 1 3/8
71 3/4	71 1 1/2

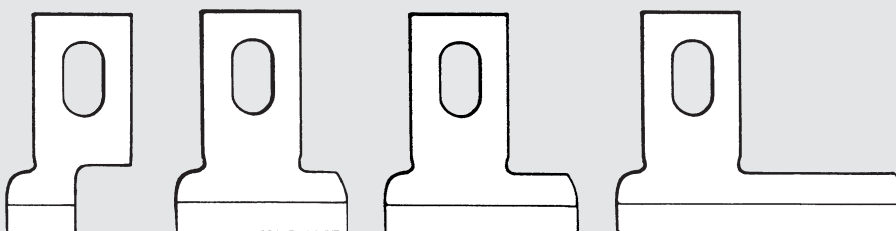

71-90 1/8	71-90 5/8
71-90 1/4	71-90 11/16
71-90 5/16	71-90 3/4
71-90 3/8	71-90 13/16
71-90 7/16	71-90 7/8
71-90 1/2	71-90 15/16
71-90 9/16	71-90 1



**DH 4-B 980**  
**RH-9800, RH-9810, RH 981 A**  
**RH-9820**



S 35411-001



S 35410-001



SA 7547-101



SA 7634-101

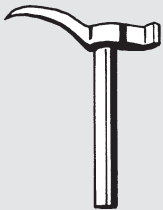

S 35412-101

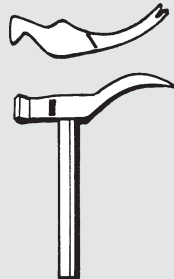

S 35413-101

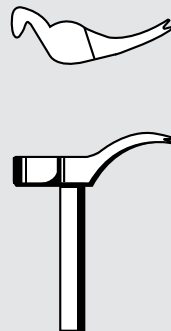

S 35472-101



S 34895-001

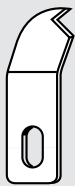

S 35029-001



S 37723-101



S 35033-001



S 35034-001

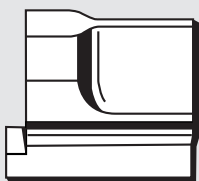

S 35092-001 20 mm  
S 35093-001 38 mm

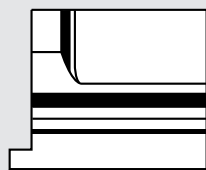

S 37195-001

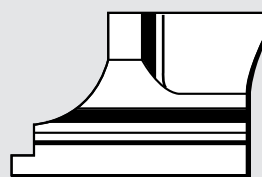

S 37706-001

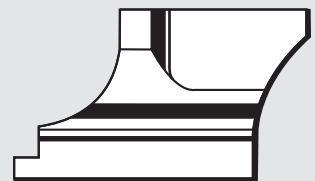

S 37708-001



**DH 4-B 980  
RH-9800, RH-9810, RH 981 A  
RH-9820**

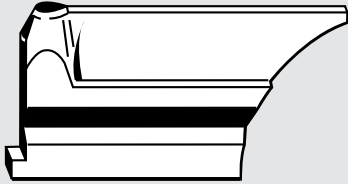

S 35437-101 (38 mm 2,8 x 4,3)

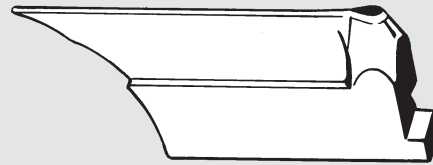

S 35480-101 (38 mm 3,0 x 4,6)

**DA 9270, 9280**

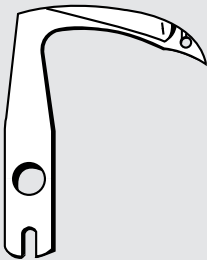

S 40389-001

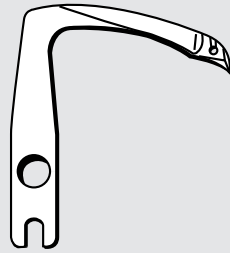

S 40390-001

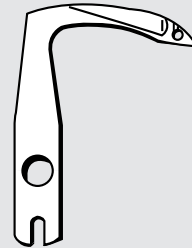

S 40391-001

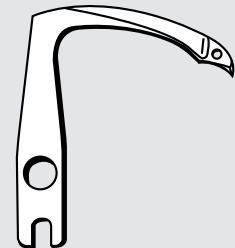

S 40392-001

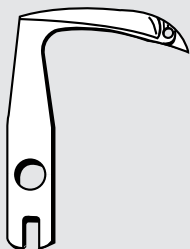

S 40393-001

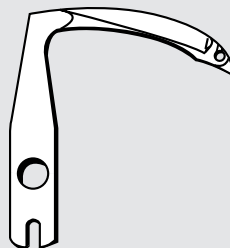

S 40394-001

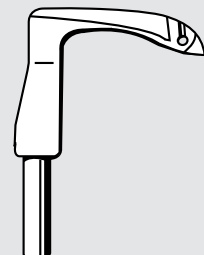

S 40375-001

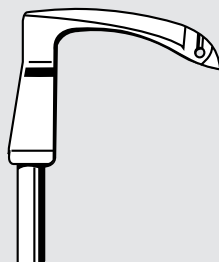

S 40376-001

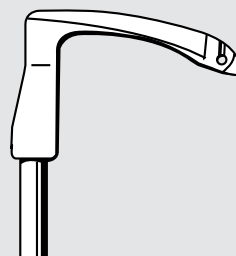

S 40377-001





LT 2-B 842, LT 2-B 875  
T-8422A, T-8452A, T-8722A, T-8752A  
TN-842B

T-8422B, T-8452B  
T-8722B, T-8752B

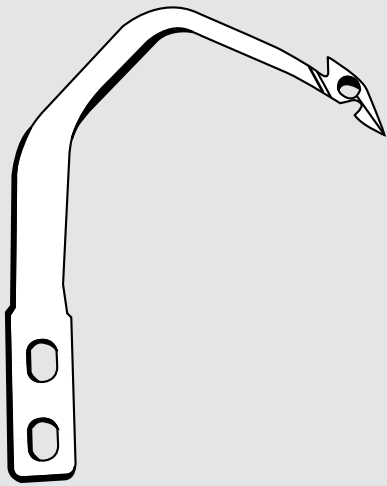

S 07526-001

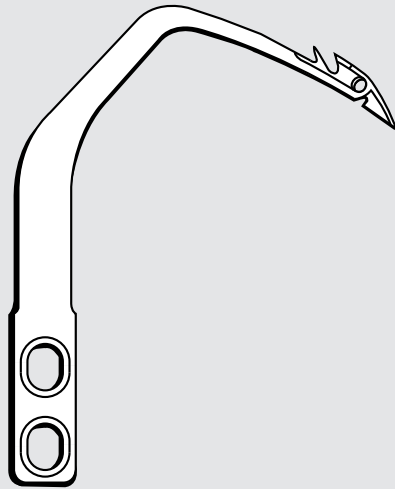

S 07526-201



S 07527-001

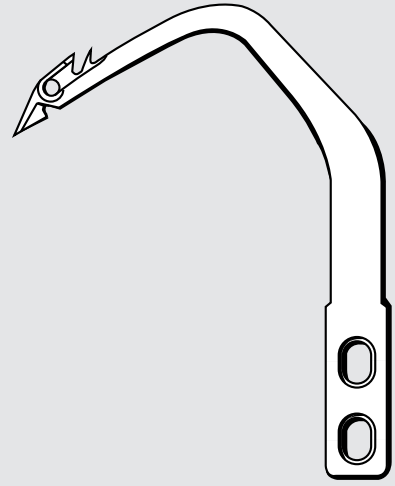

S 07526-301

B 912, B 913, B 915, B 917  
BM-916 A, BM-917 A, BM-917 B, BM-917 C



115069-001



S 03536-001

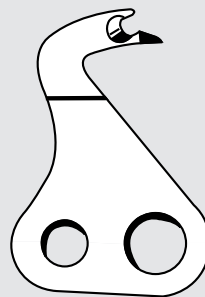

S 03627-001



S 03629-001

LS 52-B 891



SSSS 60-302

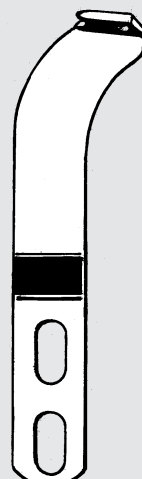

SSSS 60-292



**ZE-856A**



S 55863-101



S 55864-001

**B 926-6A**

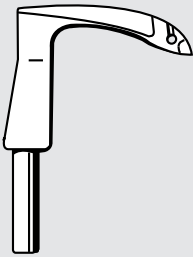

148869-001

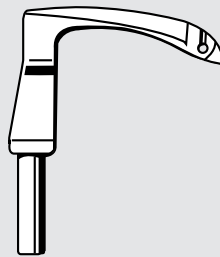

148870-001

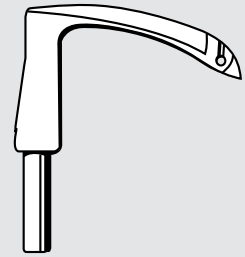

148871-001

**B 928**

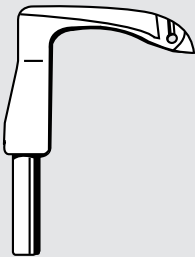

S 40375-001

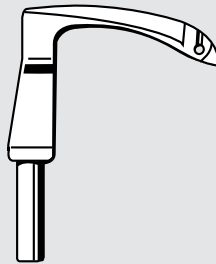

S 40376-001

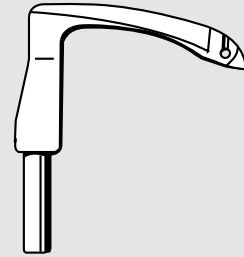

S 40377-001

**Homelock**

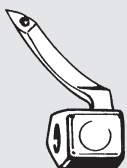

127814-001  
Kl. 127

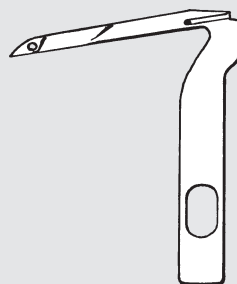

127815-001  
Kl. 127

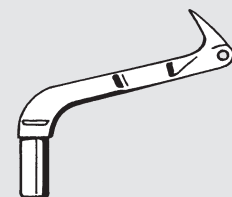

127260-001  
Kl. 522



**B 500 Series, B 600 Series, B 900 Series**

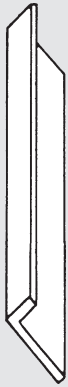

140567-001



CT 140567-001



140242-001 (CT)



148815-001 (CT)



148198-001



144074-001 (CT)

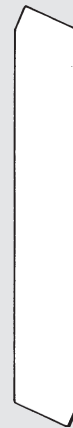

118527-001



144077-001



CT 144077-001

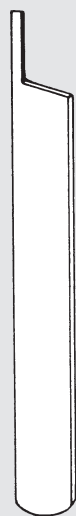

112376-001

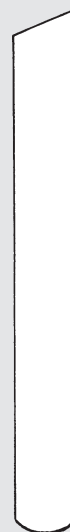

112436-001  
155193-001



CT 112436-001



**B 500 Series, B 600 Series, B 900 Series**

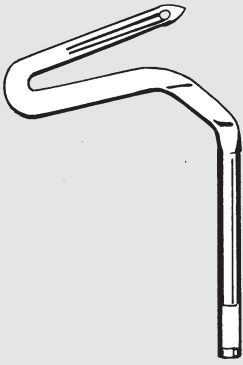

110736-001

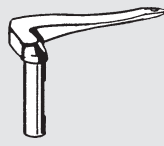

110737-001



147934-001  
146042-001  
146612-001



147935-001  
146613-001

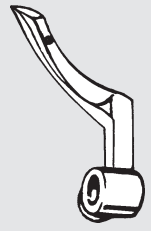

147936-001  
146792-001

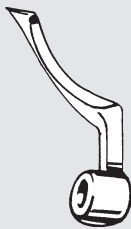

147937-001  
146962-001



144042-001



159686-001



155240-001



155241-001

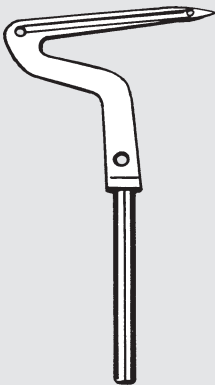

143734-001

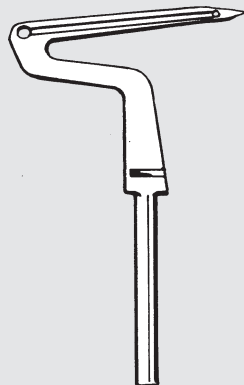

S 01248-001 (E)  
144049-001

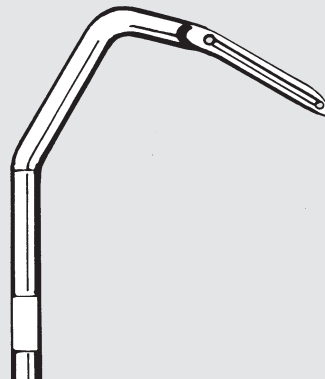

146635-001

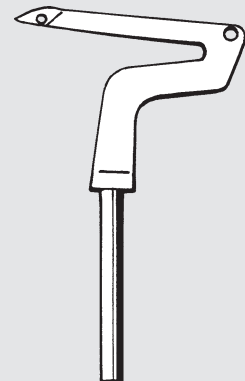

159434-001 (F)  
S 01249-001



EF 4-V 41, -V 51, -V 71, -V 72, -V 81, -V 82  
MA 4-N 11, -N 21, -N 31, MA 4-V 61, -V 91, -V 92



S 20896-101

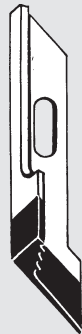

S 20897-001



S 20579-001

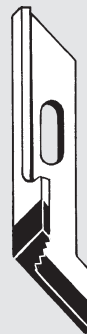

S 20898-001



144074-001 (CT)



144074-300  
144074-200



S 20899-001



S 20582-001



CT S 20582-001



S 20583-001

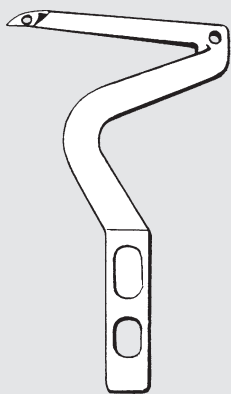

S 20626-001

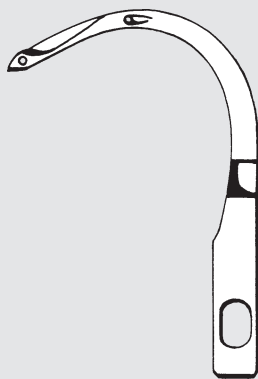

S 20653-001



S 20428-001  
V 41 (C)



S 20438-001  
V 41 (G)



S 20422-001  
V 41 (A)



S 20424-001  
V 41 (B)



S 20430-001  
V 41 (D)



S 20434-001  
V 51 (E)



S 20440-001  
V 51 (K)



S 20442-001  
V 61 (R)

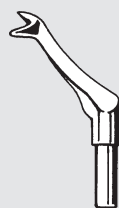

S 20421-001  
V 61 (L)



S 20423-001  
V 61 (M)



S 20429-001  
V 61 (Q)



GP 1-71  
7000010071



GP 2-71  
7000020071



GP 3-4-71  
7000030071



GP 5-71  
7000050071

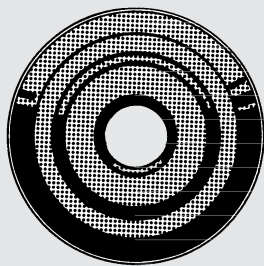

GP 1-88  
7000010088



GP 4-93  
7000040093



GP 7-71  
7000070071



GP 7-93  
7000070093

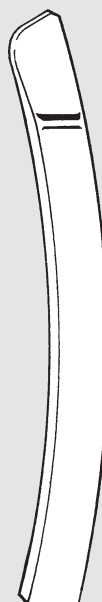

GP 8-71  
7000080071

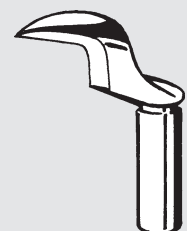

GP 8-93  
7000080093



77

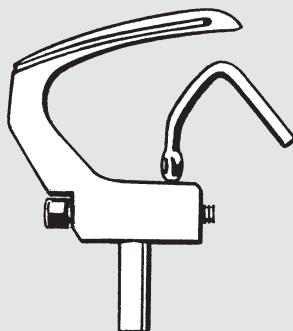

0077015050

68, 268, 368



0068004600  
68460



0068004620  
68462  
0268330470



68668-3,1



0268350030



0268350010

81



0081000820  
81082



0081000660  
81066



0083000820  
83082



0081005820  
81582 (CT)

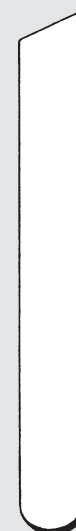

0083000660  
83066



67, 167, 267, 367, 467, 477, 550, 767, 768

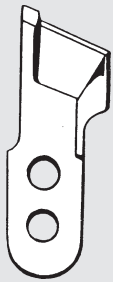

0367331330 (HSS)  
067330570



0367331310 (HSS)  
067330580



0367331320 (HSS)  
067330700



0367331300 (HSS)

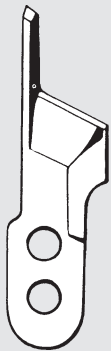

0067000460 (HSS)



0067000462 (HSS)



0067351220



0167350010



0067351230



0067009360



0367330780 (HSS)



0167004610



0167004620



0167330020 (CT)



0367210240 (HSS)



CT 367210240



0477200140





**67, 167, 267, 367, 467, 477  
550, 767, 768**

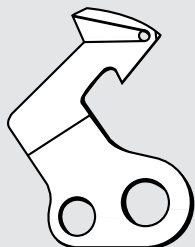

0367355030

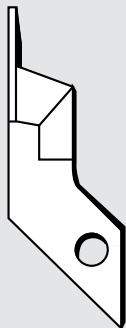

0477330240

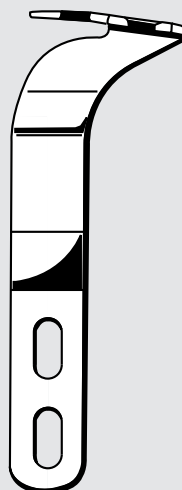

0767350280



0767350260

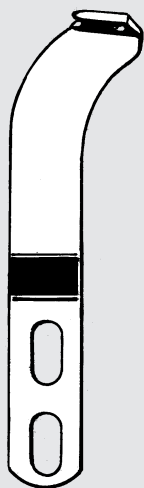

0367350070



0367350050



0467350330



0467350450



0370221570

**171, 173, 195, 197  
550  
742, 743, 744  
933, 939**

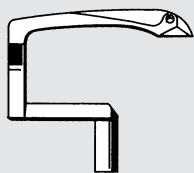

0933000337

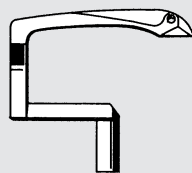

0933000337 A

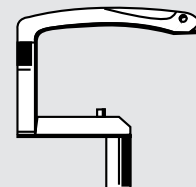

0195004753

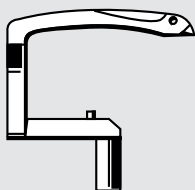

0195004753 A

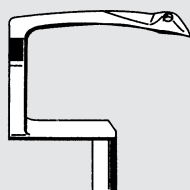

0195005055

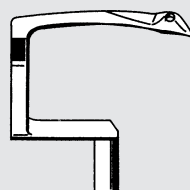

0195005055 A

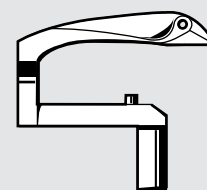

0171003253



**171, 173, 195  
550  
742, 743, 744  
933, 939**



0196104017

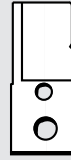

0171004602

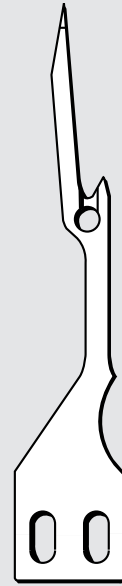

0933063983

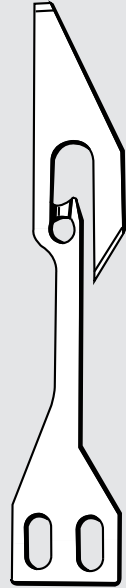

0939017104

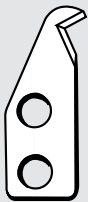

0933005712

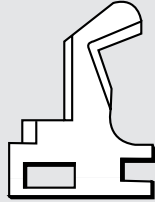

0173003725

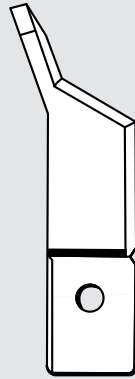

0195010127



0939017504

**211, 212, 219  
370, 380**

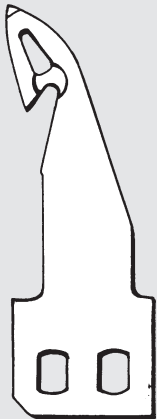

0219006708 A

**227, 237, 238, 249, 265  
697, 739-23**

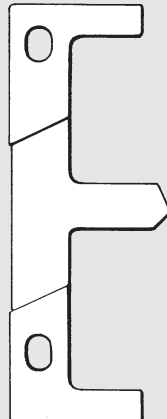

0211009685

**271, 272, 273, 274, 275**

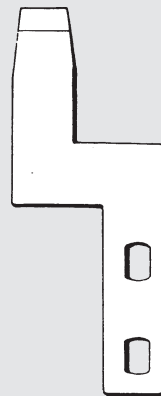

0211050366

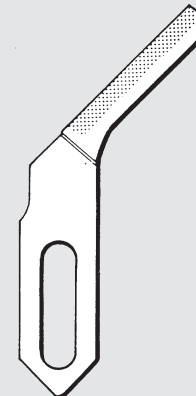

0212011368  
0212005058 (CT)



0204001065  
Kl. 237-22 und 23



0227000683



0212004931 (CT)

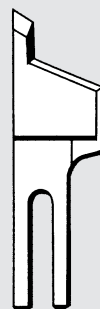

0227000682



0697002075 (CT)



0219003963  
Solid carbide  
Metal solide duro



**211, 212, 219  
370, 380**

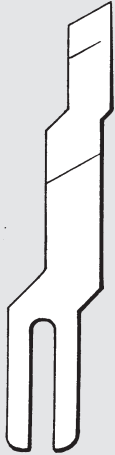

0238001418 (HSS)

**227, 237, 238, 249, 265  
697, 739-23**

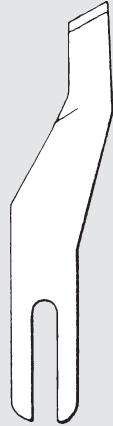

0238001417 (HSS)



0238016496

**271, 272, 273, 274, 275**

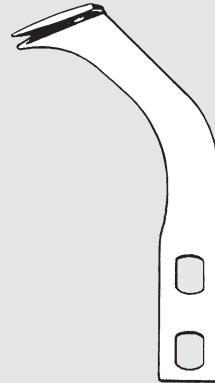

0380007293

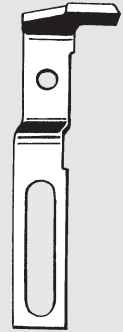

0238006549

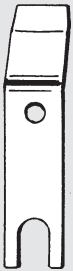

0271001497

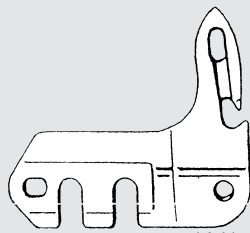

0271001483



0272076157

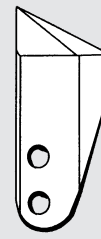

0272007042

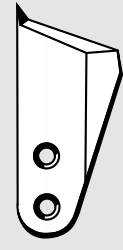

0272007045

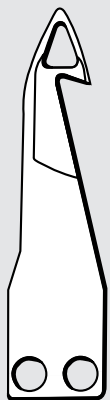

0265008772

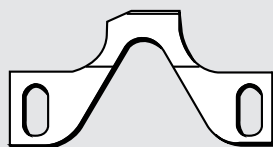

0265012265

**244, 245, 246, 247  
291, 292  
745**



0244014157



0291003002

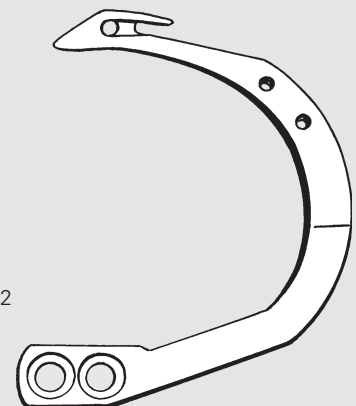

0291003004  
0244014161



296



0296200020



0296330430 (CT)

396, 550



0396350750



0396200090

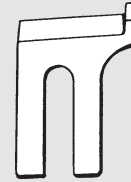

0396330690



0396330700

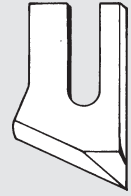

0396331600



0170200190

251

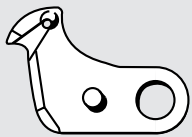

0251GR2438V2

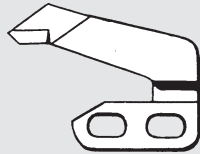

0251GR1705

564, 566

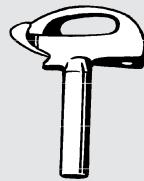

180614 DKP



0568330770



0568330760

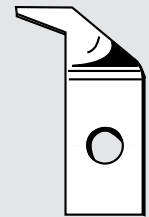

0568350050

570, 579

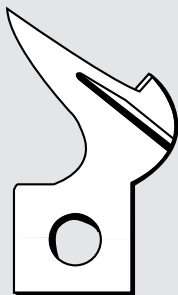

0570000961

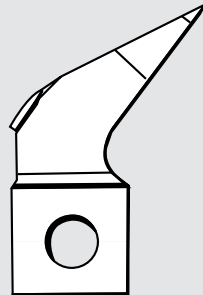

0570000962

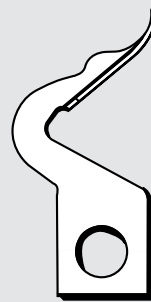

0570092921

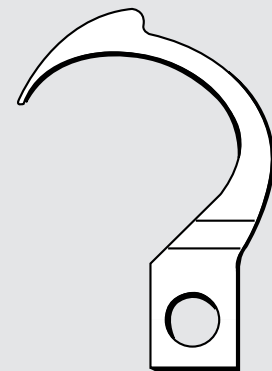

0570092925

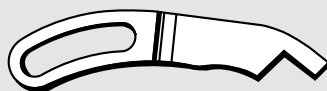

0570092917 A



0570092908 A



## 551, 555, 556, 576, 577, 540-100, 540-300

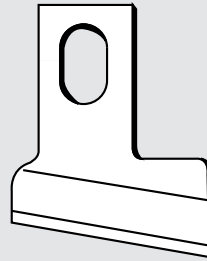
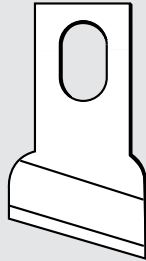
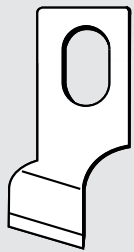

	mm		mm	Zoll
0576005701	6	0055000602	12,7	1/2
0576005702	8	0055000603	15,9	5/8
0576005703	10	0055000606	19,1	3/4
0576005704	12			
0576005705	14			
0576005706	16			
0576005707	18			
0576005708	20			
0576005709	22			
0576005710	24			
0576005711	26			
0576005712	28			
0576005713	30			

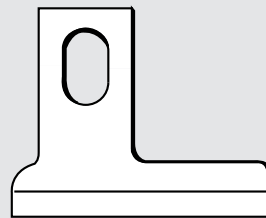
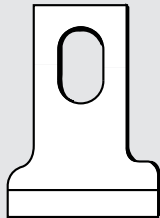

	mm		mm	Zoll
0576005721	6	0556007143	9,5	3/8
0576005722	8	0556007144	11,1	7/16
0576005723	10	0556007146	14,3	9/16
0576005724	12	0556007148	17,5	11/16
0576005725	14	0556007149	19,1	3/4
0576005726	16	0556007151	22,2	7/8
0576005727	18	0556007152	23,8	15/16
0576005728	20	0556007157	31,8	1 1/4
0576005729	22			
0576005730	24			
0576005731	26			
0576005732	28			
0576005733	30			
0576005734	34			

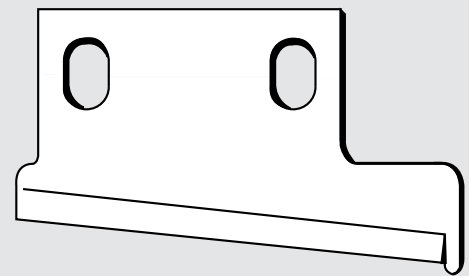
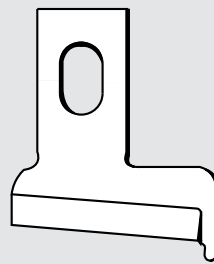
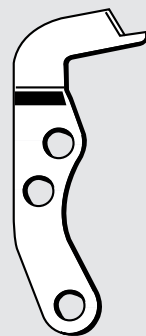
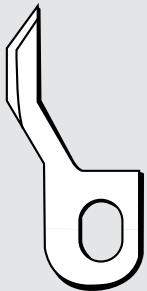

0540330110

0556013536

0556012783

0556012772

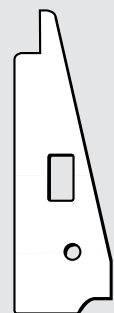
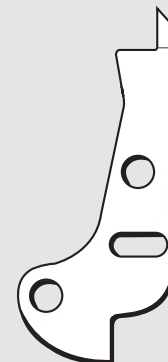
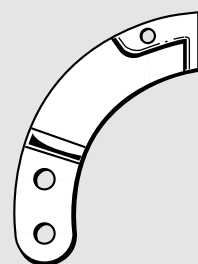
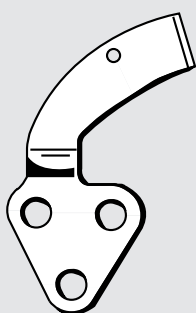

0577350230

0577350240

0577350080

0540350290

0540350340

0540350350



557, 558, 559, 578, 579, 580, 589



0557002872  
(557605)  
Bohrung 0,6



0557002872 A  
Bohrung 0,8



0557003243  
Bohrung 0,9



0557000602 A

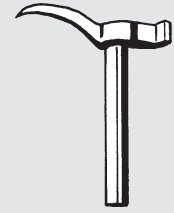

0557000611



0558009011

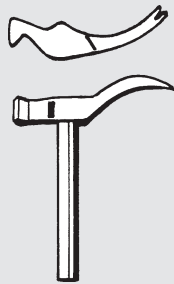

0557002876 K  
(557614)

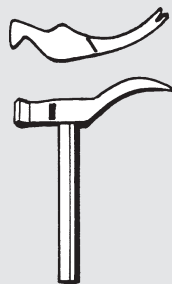

0557002035

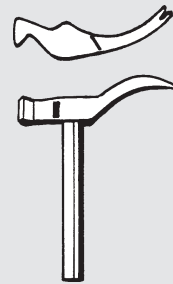

0557003398

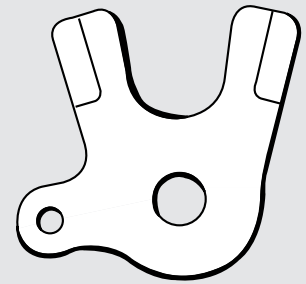

0557000593

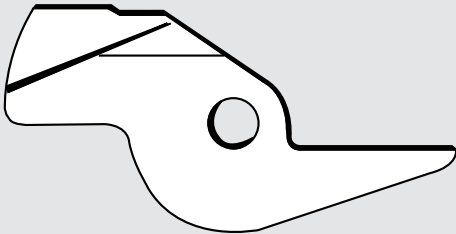

0558006110

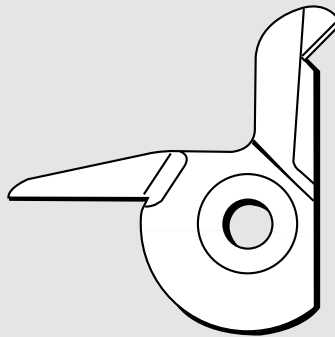

0558006109

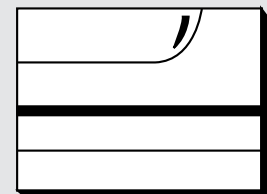

0557001684 MS  
0557001686 MS

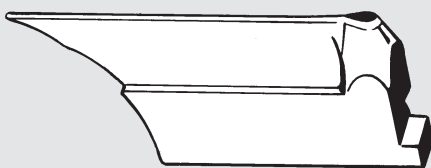

0558002561  
0558002562  
0558002566

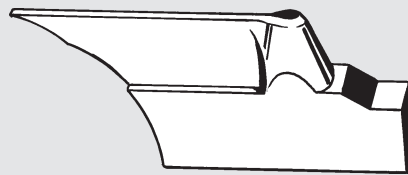

0558002564  
0558002565  
0558002567

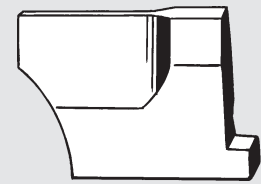

0558002405 16 mm  
0558002406 18 mm  
0558002408 22 mm  
0558002410 26 mm  
0558002411 28 mm  
0558002414 38 mm



## 557, 558, 559, 578, 579, 580, 589

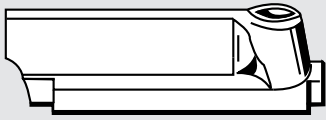

0578003363

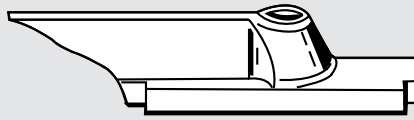

0578003365

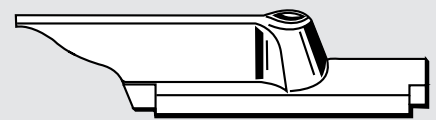

0578003366

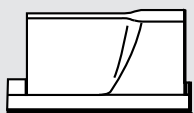

- 0578003281 10 mm
- 0578003282 12 mm
- 0578003283 14 mm
- 0578003284 16 mm
- 0578003285 18 mm
- 0578003286 20 mm
- 0578003287 22 mm
- 0578003288 24 mm



- 0578003289 26 mm
- 0578003290 28 mm
- 0578003291 30 mm
- 0578003292 32 mm
- 0578003293 34 mm
- 0578003295 38 mm

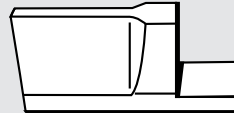

- 0578003323 20 mm
- 0578003324 22 mm

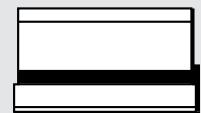

- 0578003304 12 mm
- 0578003308 20 mm
- 0578003309 22 mm
- 0578003311 26 mm
- 0578003314 32 mm
- 0578003315 34 mm
- 0578003316 38 mm

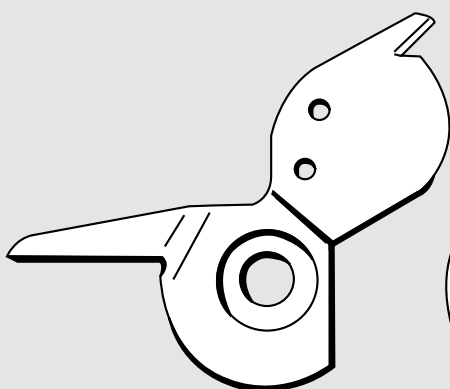

0558008816

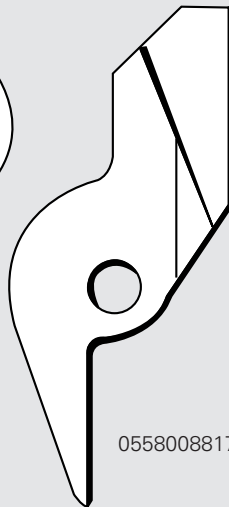

0558008817

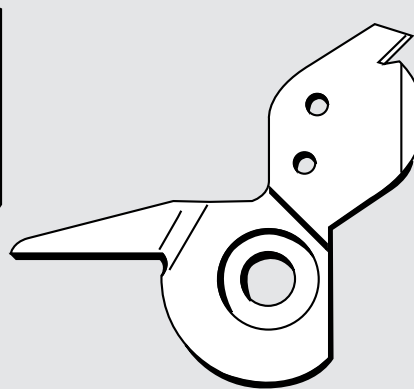

0558008858

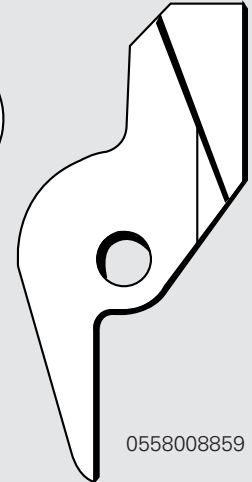

0558008859

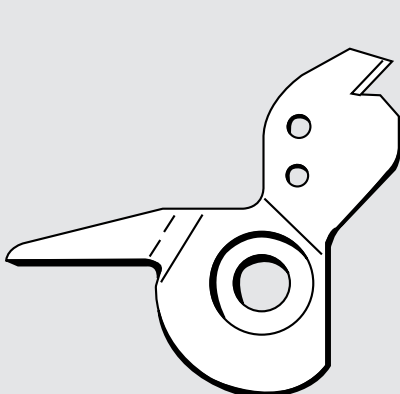

0558008868

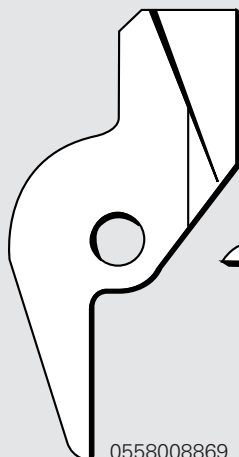

0558008869

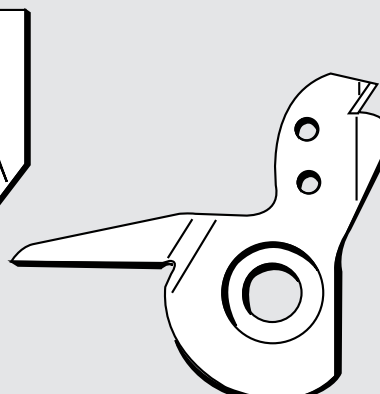

0558008878

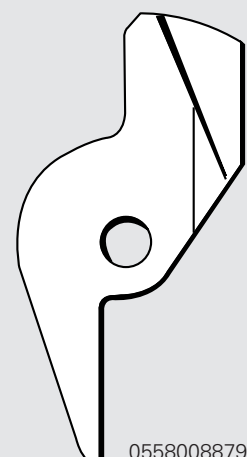

0558008879



580

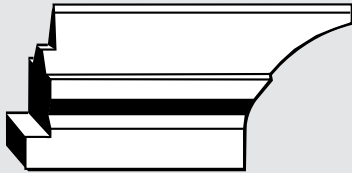

0558002552

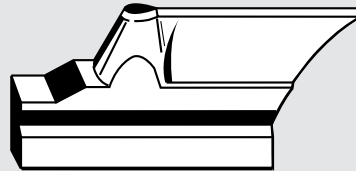

0558006855

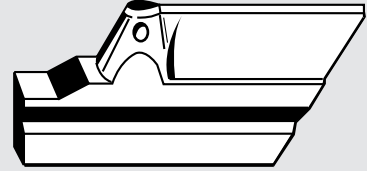

0580330370

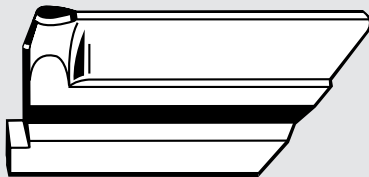

0580330390

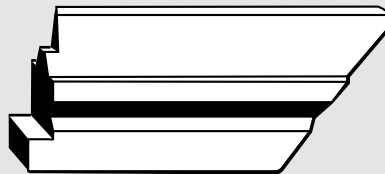

0580330400

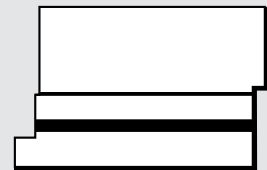

0580330300

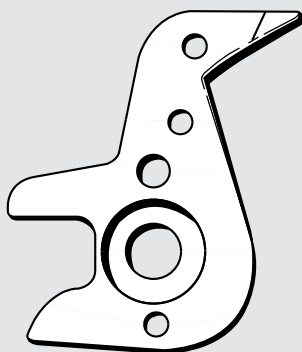

0580350280

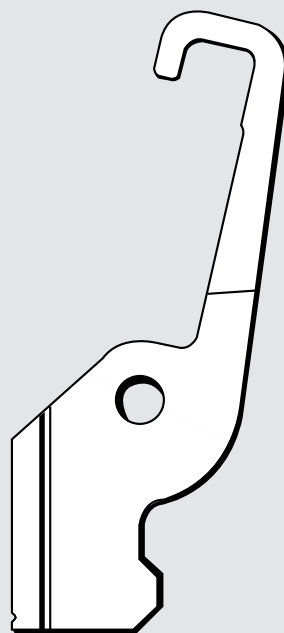

0580350270

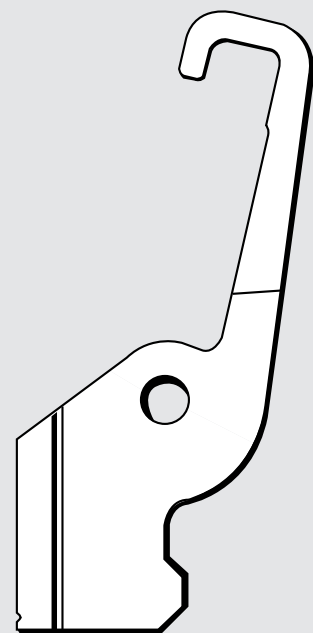

0580350970





745, 746, 748, 749, 745-34 S  
745-21, 745-22

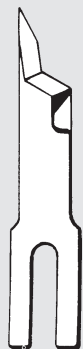

0246002553



0246002706  
Solid carbide  
Metal solide duro

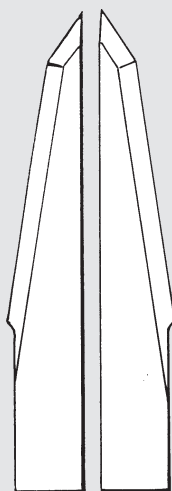

0746060689 0746060690

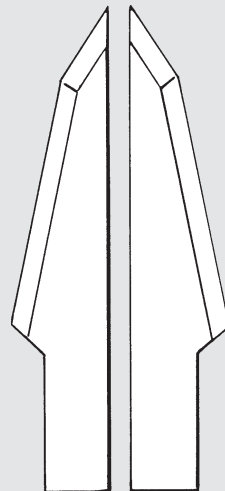

0746060691 0746060692

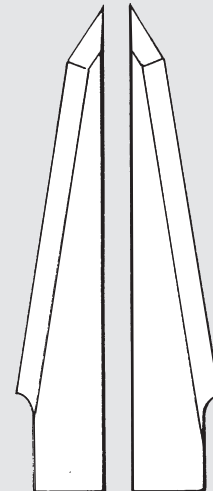

0746000995 A 0746000995

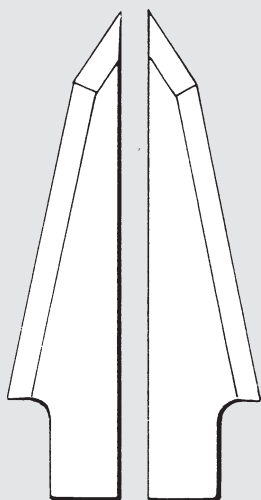

0746000996 A 0746000996

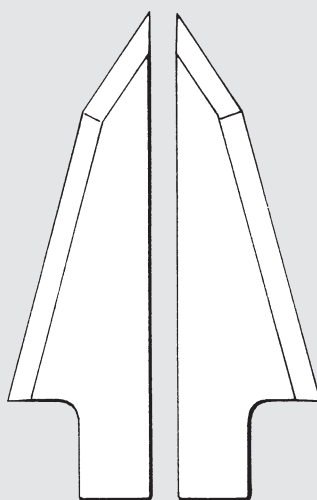

0746000997 A 0746000997

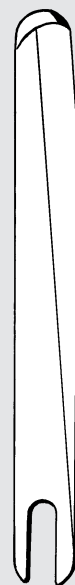

0748000419

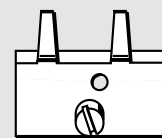

0246002401

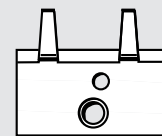

0246002402

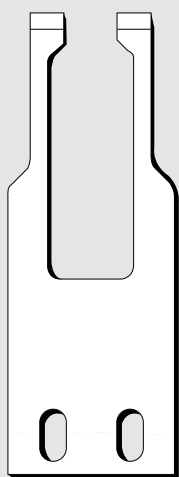

0246350040

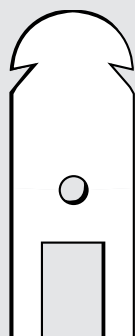

0246350060

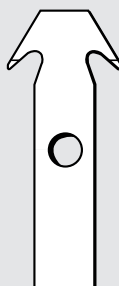

0246000595

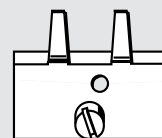

0246002405

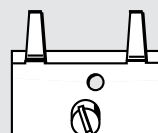

0246002408

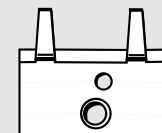

0246002409



3000



0793027524

971



0971440140



0971440180



CT 971440140

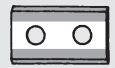

CT 971440180

1296

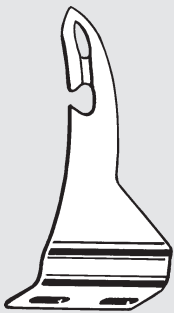

0129175540



0129171853

867

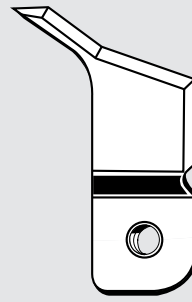

0867330270



0867330430

510, 530, 910

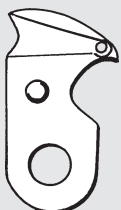

0510350033

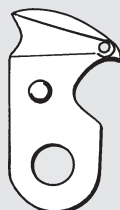

0510 B 2421-280-0A0

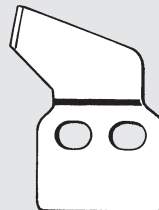

0510 B 2424-280-000



0510350060



4120 i, 4180 i, 4181 i, 4182 i, 4182 i - 147  
4220 i, 4280 i  
888

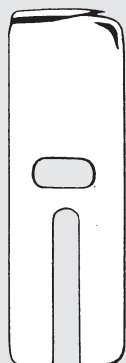

S 425311020 = 2,7  
S 425311026 = 3,5

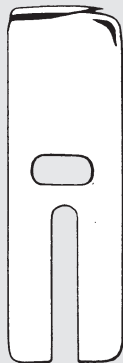

S 425311020 HSS = 2,7  
S 425311026 HSS = 3,5



S 425311023



S 425311024



S 425311018



S 425311018 HSS



S 425311021



S 425311021 HSS

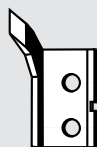

S 080870223



S 080870238



S 080870239



S 425870237  
Solid carbide  
Metal solide duro



21-5602  
Kl. 1010/1020:  
520087  
Kl. 2001:  
6502114  
PL-2-13



21-3002  
21-4012  
520018  
PL-2-30 (CT)



21-4587  
512035



21-3003  
650704  
527013  
PL-9-9  
HSS

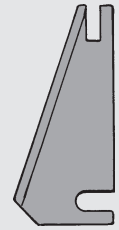

15487  
21-3003-01  
6507044  
Ceramic



21-4001  
520002  
Kl. 1005F/1005FZ



21-3004  
512018  
Kl. 1002

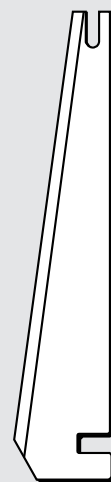

MS 3-017 L

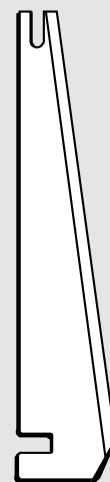

MS 3-017 R

MUSASHI-21



LBH 761-763, 771-773, 781-784, LBH 793  
LBH 1700, LBH 1790, LBH 781NS  
ACF 172-1790

HSS=  
High Speed steel  
Acero rápido de  
alto rendimiento

= Singer Kl. 71

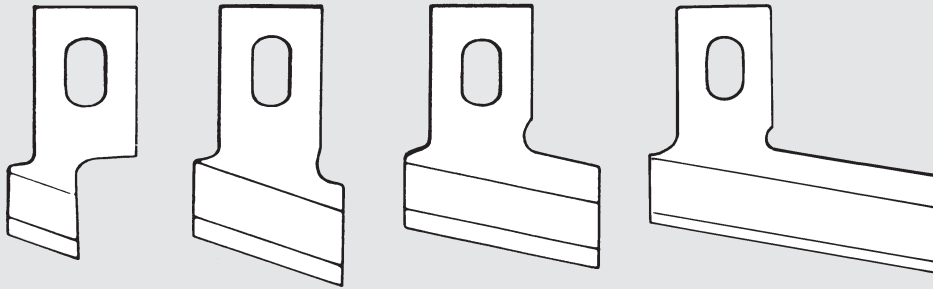

B 2702-047-F00	1/4"
B 2702-047-K00	3/8"
B 2702-047-I00	7/16"
B 2702-047-L00	1/2"
B 2702-047-V00	9/16"
B 2702-047-M00	5/8"
B 2702-047-A00	11/16"
B 2702-047-N00	3/4"
B 2702-047-P00	7/8"
B 2702-047-Q00	1"
B 2702-047-S00	1 1/4"
B 2702-047-R00	1 1/8"

= Singer 71-90

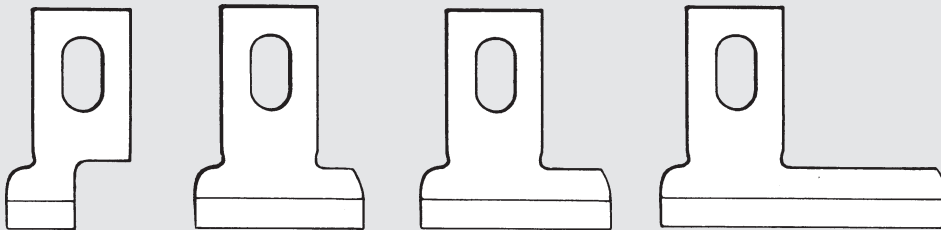

B 2745-771-F00	1/4"
B 2745-771-K00	3/8"
B 2745-771-L00	1/2"
B 2745-771-H00	9/16"
B 2745-771-M00	5/8"
B 2745-771-N00	3/4"
B 2745-771-P00	7/8"
B 2745-771-Q00	1"

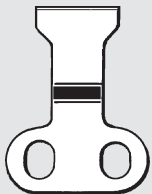

B 2408-761-000

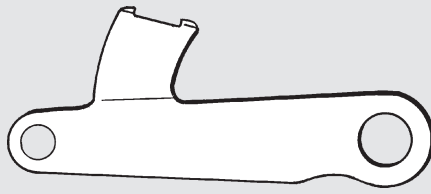

B 2406-761-0A0

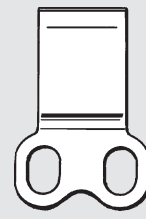

B 2408-771-000

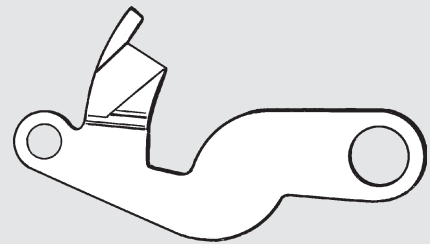

B 2406-771-0A0

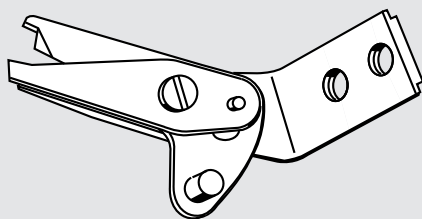

B 2001-771-0A0

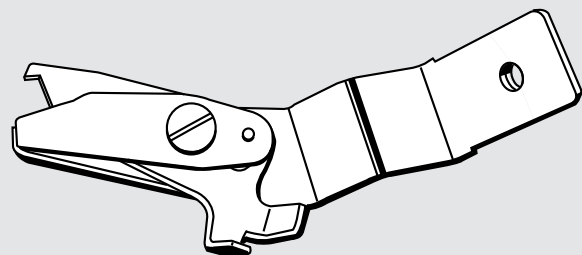

400-04255



**MBH 180, MEB 1890 = Reece S 200**

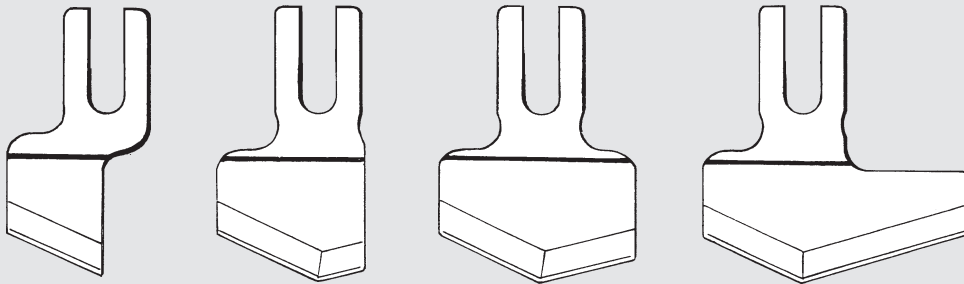

B 2701-180-F00	1/4"
B 2701-180-K00	3/8"
B 2701-180-L00	1/2"
B 2701-180-V00	9/16"
B 2701-180-M00	5/8"
B 2701-180-N00	3/4"
B 2701-180-P00	7/8"
B 2701-180-Q00	1"
B 2701-180-R00	1 1/8"
B 2701-180-S00	1 1/4"
B 2701-180-T00	1 3/8"

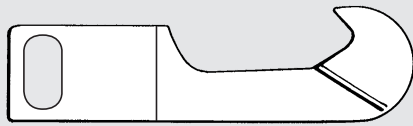

B 4002-180-000



B 1109-180-000



B 4001-180-000



B 2523-180-000



B 2524-180-000

**MO 102, 103, 104, 202, 204, 234, 305, 335 Bernette**



B 4108-352-00D (CT)



A 4113-102-000



A 4142-335-000 (CT)



A 4145-335-000

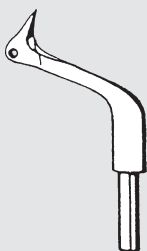

A 2512-102-000

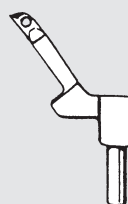

A 2512-103-000

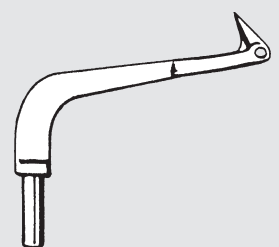

A 2511-202-000



**APW Series**



164-16109  
164-18600  
SUPER-Stahl  
SUPER-steel

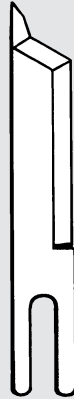

164-18709  
164-18006  
SUPER-Stahl  
SUPER-steel



166-07400  
SUPER-Stahl  
SUPER-steel

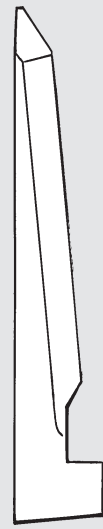

166-07301  
SUPER-Stahl  
SUPER-steel



254-43805  
SUPER-Stahl  
SUPER-steel



254-46808  
SUPER-Stahl  
SUPER-steel

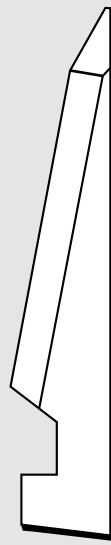

166-07608  
SUPER-Stahl  
SUPER-steel

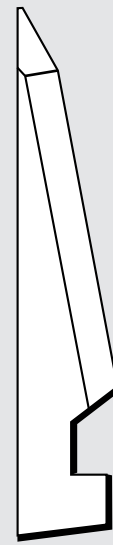

166-07509  
SUPER-Stahl  
SUPER-steel

**LK 280, 980, 1850, 1900, 1900A  
1903A, 1910, 1920, 1930  
AB 1351**

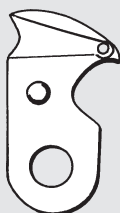

B 2421-280-0A0

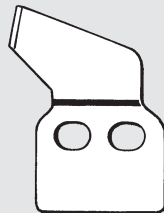

B 2424-280-000

**MB 372, 373, 377, 1370, 1373, 1377, 1800  
AMB 289**



B 1239-372-000

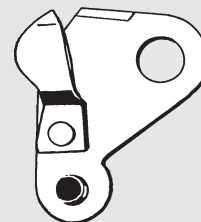

B 2406-373-0A0



B 2410-373-000



**MO 352, 357**



B 4108-352-00D (CT)

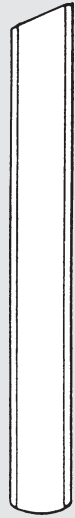

B 4122-352-00 A

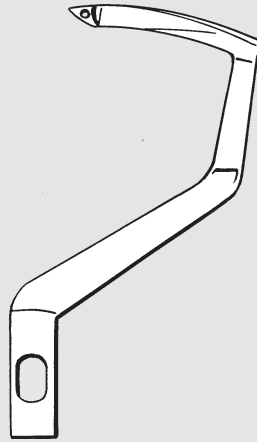

B 2011-357-000

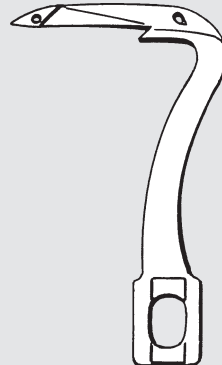

B 2521-352-000

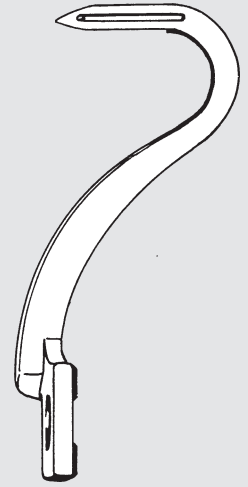

B 2520-352-000

**DLM Series  
DMN Series**

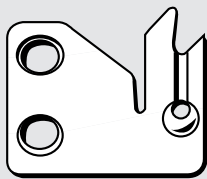

113-51400



113-51509

**AMS 210, 212, 215, 221, 223, 224**

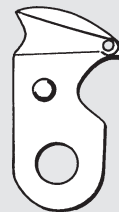

B 2421-205-0A0



B 2424-210-000

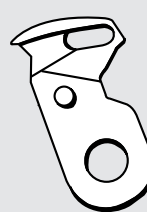

B 2421-210-AA0

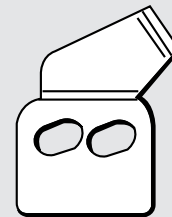

B 2424-210-A00



B 2421-210-000



B 4121-052-A00



B 4121-522-000



B 4145-530-B00

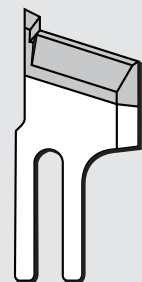

B 4145-530-B0A





**DDL 555, 5550, 5570, 5580, 5600, 5700, 9000, 9000 A, 9000 B**  
**DDL 850-7, 8500-7, 8700-7**  
**DLN 415, 5410, 6390-7, 9010**  
**DLD 5430**  
**DLU 5490 N-7**

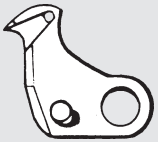

D 2402-555-BAO



D 2402-555-BAB



D 2402-415-BAO

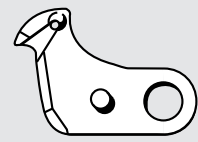

110-40052

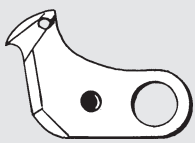

110-93259

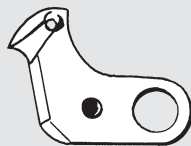

113-13053

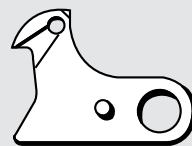

114-08150

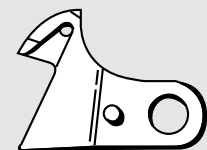

114-09257

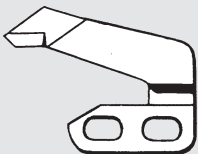

D 2406-555-BOO

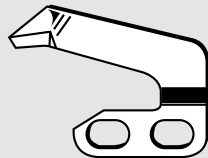

D 2406-555-DOH

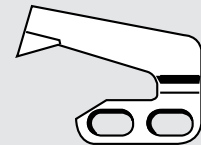

114-09604

**MF 850, 860, 880, 890, MF 2600, MFB 860, MFB 2600**

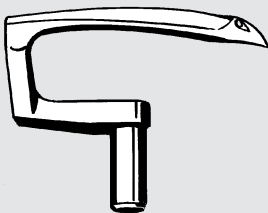

B 2514-860-G00



MAS-11012-000



MAS-11013-000

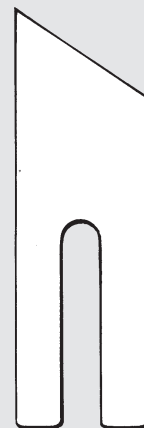

MAS-11016-000

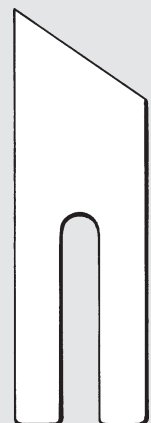

MAS-11017-000

**PLW 1257**



106-46909



106-50703



**LH 3120, 3126, 3128, 3162, 3178,  
3182, 3188**

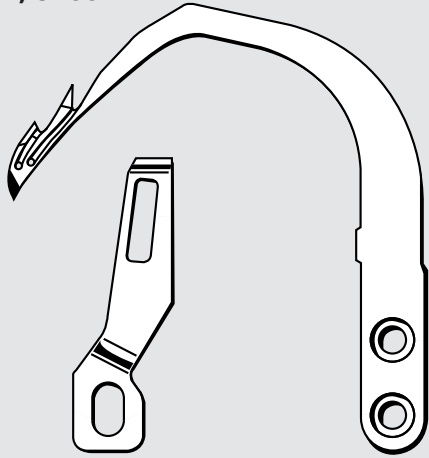

226-55302

102-11605

**LH 1152, 1162, 1164**

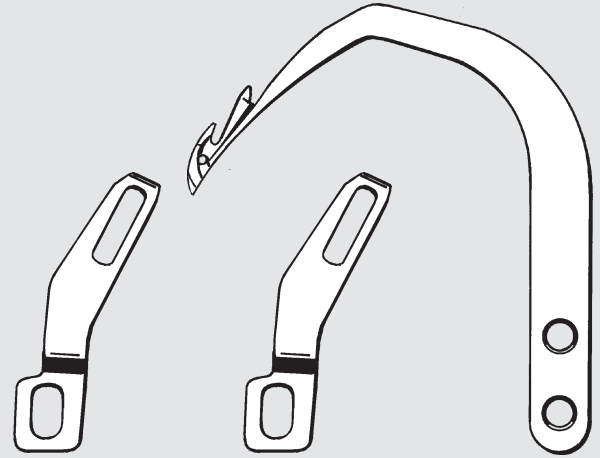

102-11209

102-32403

102-11100

102-11118

**LH 3500, 3500 A  
LH 3528, 3568  
LH 4128, 4168**

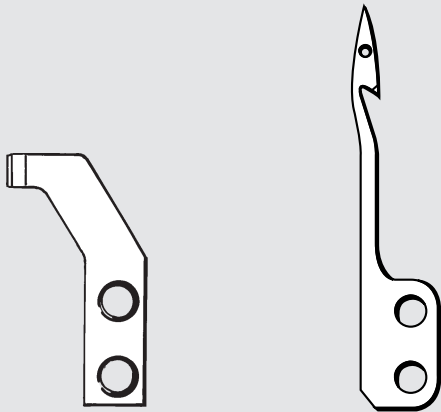

400-12404

400-12403

**LU 2210, 2112,  
LU 2216, 2220  
LU 2260, 2266**

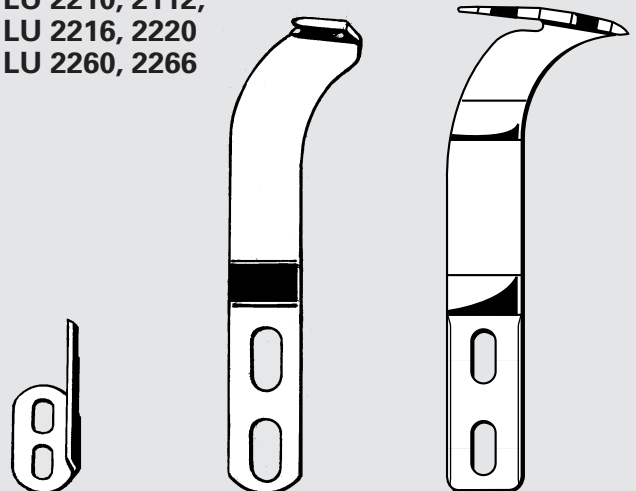

107-26404

107-26305

213-89200

**MH 481, 484**

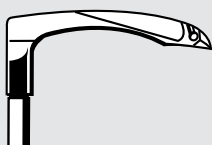

B 2030-481-000

**MH 380, 382**

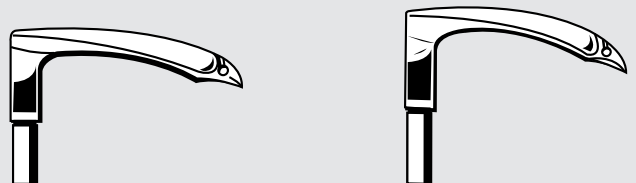

B 2030-380-000

B 2031-380-000

**MF 7000, MFC 7000**

siehe Union CS/FS 100 Seite 109  
see Union CS/FS 100 page 109  
véase Union CS/FS 100 Página 109

**MF 7600, 7700, 7800**

**MF 7200 D**

**MF 7800 D**

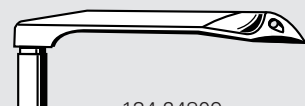

134-24809



**MS 1190**

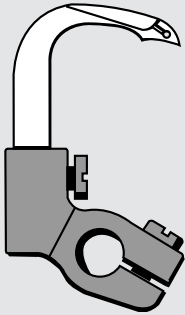

129-40557

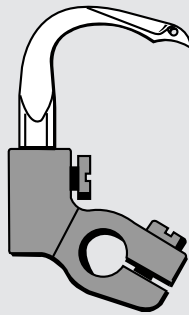

129-40656

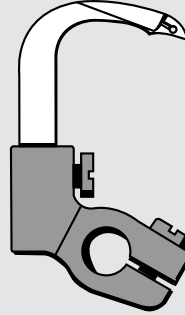

129-40953

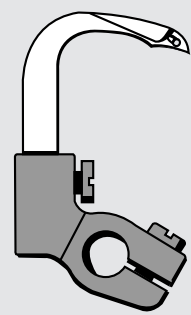

129-41050

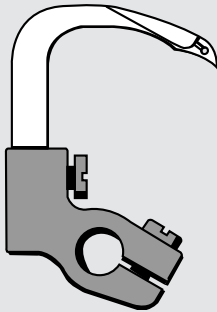

129-41456

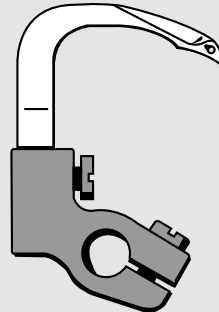

129-41852

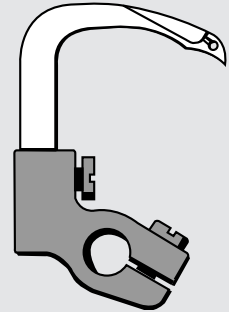

129-41951

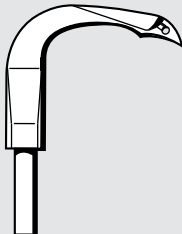

129-40508

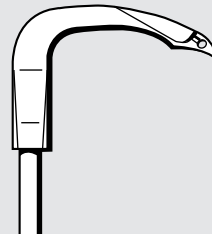

129-41407

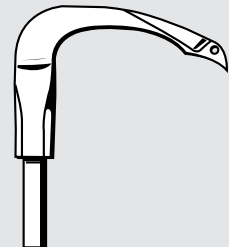

129-41555

**MS 1260, 1261, 1261 M**

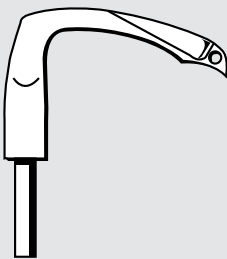

129-68509 (L)

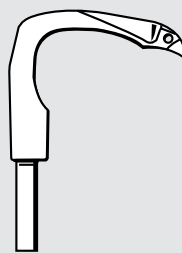

129-68806 (R)

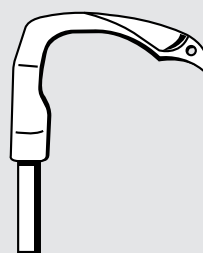

129-69101 (C)

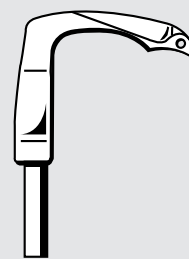

129-79308 (C)

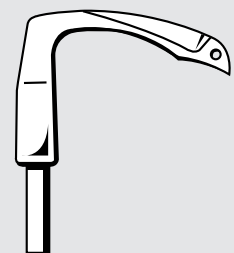

129-79209



**MS 3580**

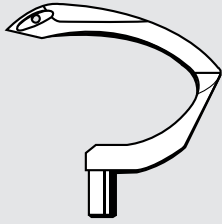

400-68298

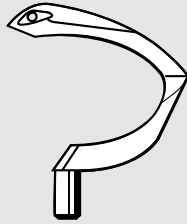

400-68299

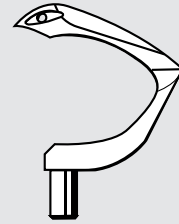

400-68300

**DU 141 H-7**



D2424-141-E00

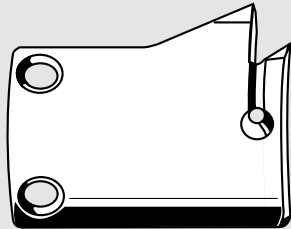

D2423-141-E00

**PLC 1610, 1660**

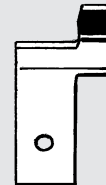

230-05903



230-05804

**MH 1410**

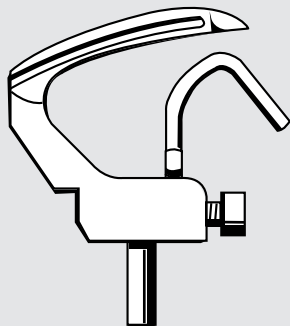

311-54503

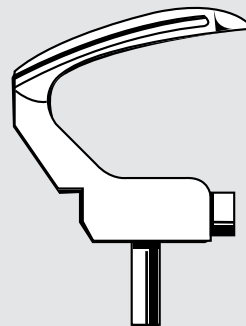

311-54602



**MO 800 Series, MO 1500 Series**  
**MO 2000, 2400, 2500 Series, MO 3300, 3600, 3700, 3900 Series**  
**MOC 3904, 3914 = Union SP 100**  
**MOR, MOJ 3916**  
**MO 6100 Series, MO 6700 Series, MO 6900 Series**



B 4111-804-000



B 4111-804-00D



B 4111-804-00A (CT)

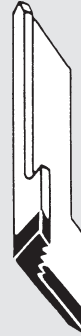

B 4111-804-00E (CT)

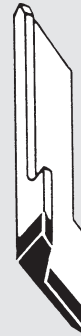

B 4111-804-00C (CT)



B 4118-804-000



B 4118-804-00C



CT B 4118-804-000

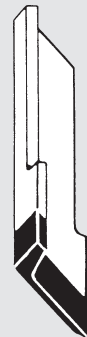

CT 118-45906



118-45807



CT 118-45807



CT 118-45807 G



115-65900 (CT)



118-45609 (CT)

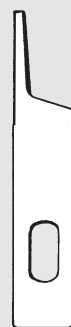

118-47407



118-45708 (CT)



118-47506



**MO 800 Series, MO 1500 Series**  
**MO 2000, 2400, 2500 Series, MO 3300, 3600, 3700, 3900 Series**  
**MOC 3904, 3914 = Union SP 100**  
**MOR, MOJ 3916**  
**MO 6100 Series, MO 6700 Series, MO 6900 Series**



120-04909 (CT)



124-45508 (CT)



131-50503 (CT)



131-50602 (CT)



118-46003



118-97501



115-98406



115-66502



122-20307

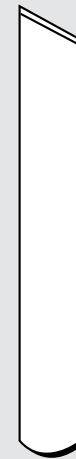

124-47504



131-50701

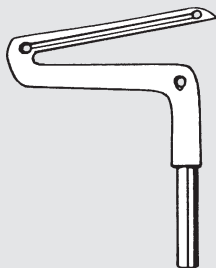

B 2521-804-000

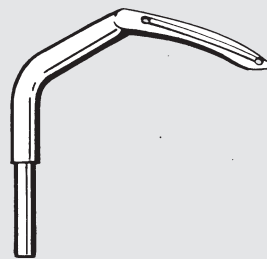

B 2118-816-000

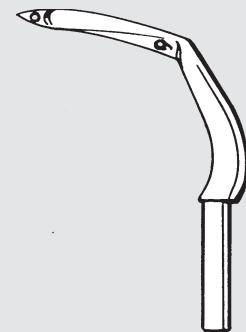

115-39202



B 2519-804-000



B 2519-814-000



B 2519-804-00B



B 2514-803-000



**MO 800 Series, MO 1500 Series**  
**MO 2000, 2400, 2500 Series, MO 3300, 3600, 3700, 3900 Series**  
**MOC 3904, 3914 = Union SP 100**  
**MOR, MOJ 3916**  
**MO 6100 Series, MO 6700 Series, MO 6900 Series**



115-44806



116-81301

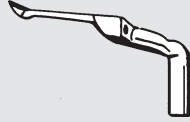

118-88005



118-88104



118-88203

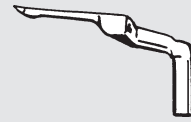

118-88302

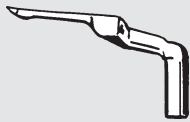

118-88609



119-91403

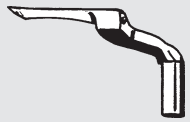

119-91908



119-93607

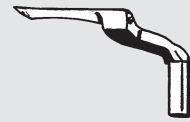

119-99208

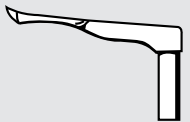

120-14908

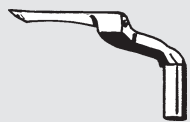

121-76004

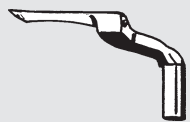

121-76103

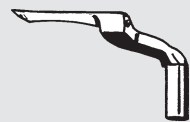

121-76202

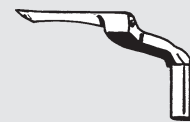

122-47102



122-47508

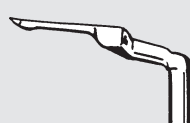

122-47300



123-83501



124-81107

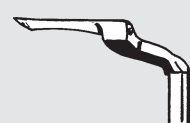

124-81008

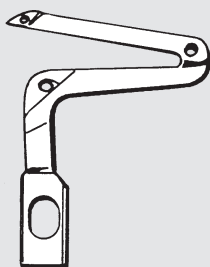

118-88401

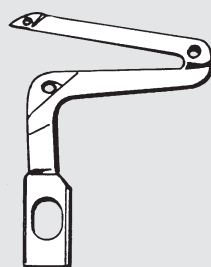

118-88500

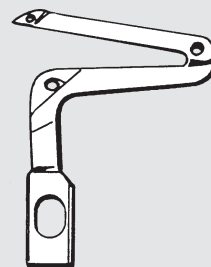

118-88501

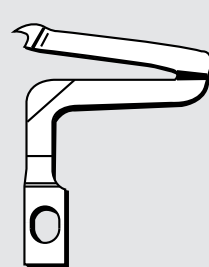

118-88708



**MO 800 Series, MO 1500 Series**  
**MO 2000, 2400, 2500 Series, MO 3300, 3600, 3700, 3900 Series**  
**MOC 3904, 3914 = Union SP 100**  
**MOR, MOJ 3916**  
**MO 6100 Series, MO 6700 Series, MO 6900 Series**

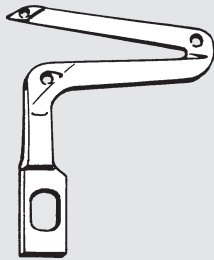

118-89904

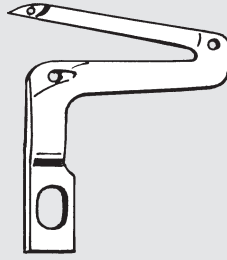

119-99307

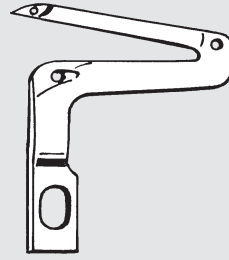

119-99802

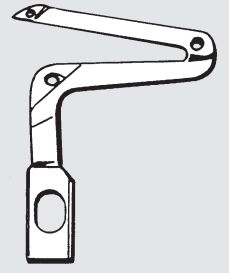

122-40107

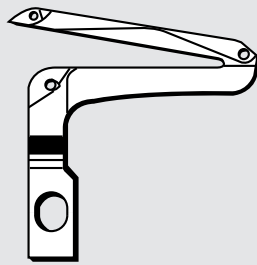

123-84202

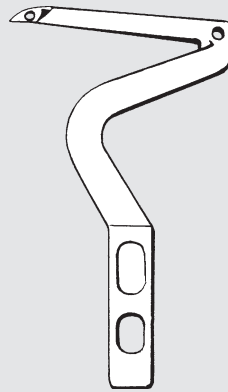

124-81800

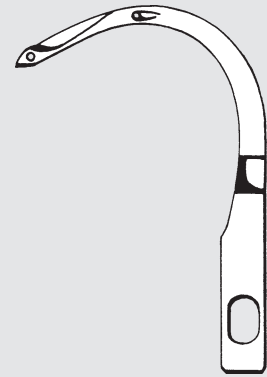

124-82600

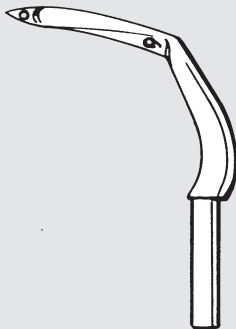

118-29405

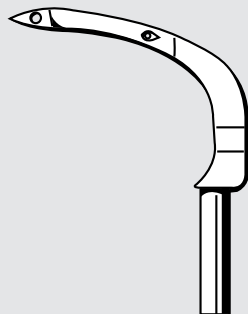

120-03604

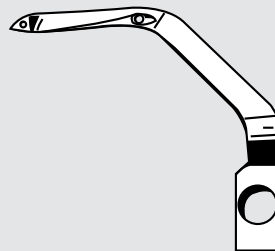

121-20705

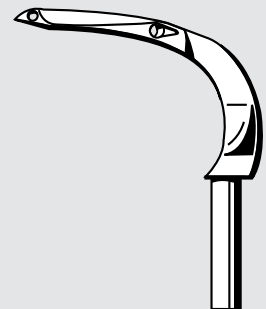

123-84400





**MO 800 Series, MO 1500 Series  
MO 2000, 2400, 2500 Series, MO 3300, 3600, 3700, 3900 Series  
MOC 3904, 3914 = Union SP 100  
MOR, MOJ 3916  
MO 6100 Series, MO 6700 Series, MO 6900 Series**

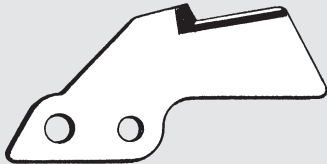

MAT-0220 3000 (CT)  
T 022, T 035

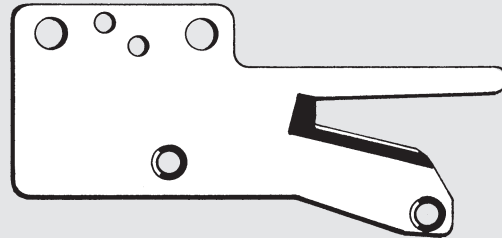

MAT-0220 4000 (CT)  
T 022, T 035

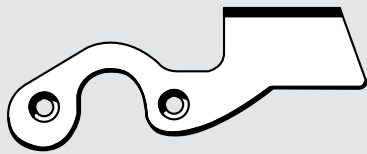

MAT-0350 6000 (CT)

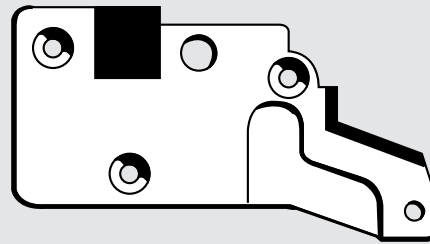

MAT-0350 5000 (CT)

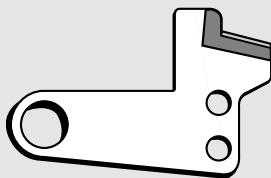

MAT-0360 6000 (CT)

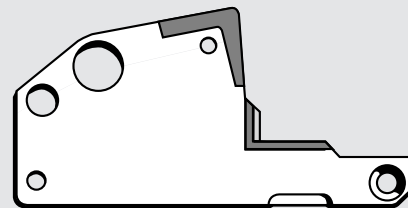

MAT-0360 500A (CT)

**LZ 2280 N, 2282, 2282 N, 2282 NU, 2286 NU, 2288 NU, 2290**

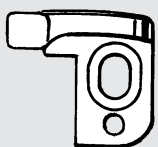

235-06009

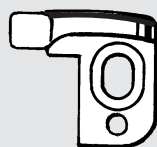

CT 235-06009

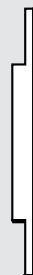

CT 235-06108  
Solid carbide  
Metal solide duro



225-57557



225-57706



**MEB 2688, 3200**



140-30803



140-30902



320-40800



400-15694

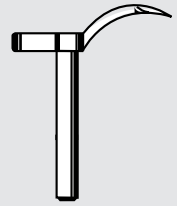

140-31017

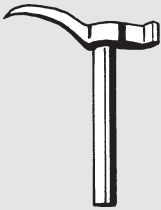

140-31009

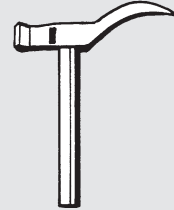

140-31108

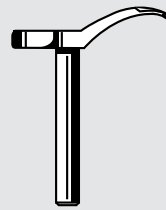

140-31116

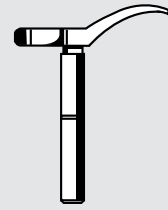

400-15684



400-15685

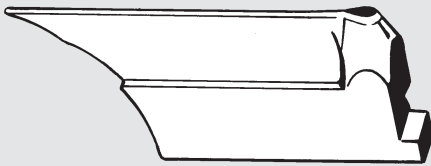

140-41206



320-16107



320-18509



320-18012

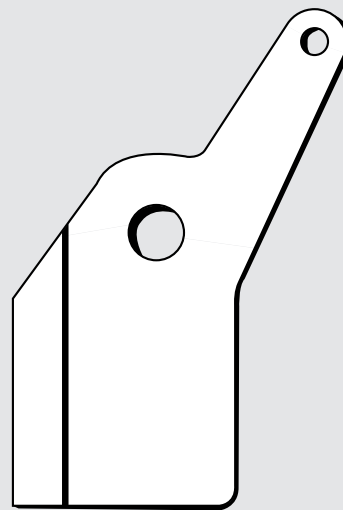

320-20505

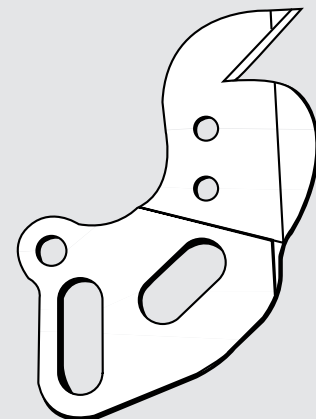

400-15996



**Babylock** EF 205, 405, 406, 434, 436, 605, 738  
BL 3-408, 418  
BL 4-605

SL 330, 500, 800, 803, 843  
BL 3200



305249



205-9102-01 A (CT)



305248  
205-9101-01 A



405-9102-01 A

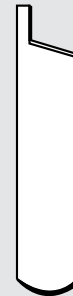

408-9101-01 B



408-9102-01 A



PL-Q11-01 A

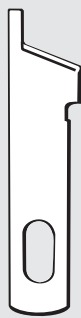

PL-Q11-01 C



PL-R11-01 A



SE-R11-01 A

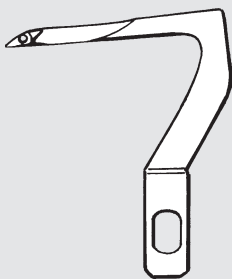

418-6101-02 A



714-6101-01 A



60507 (CT)

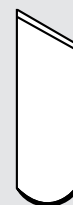

60544



**DPW-1300 / PX-302  
V 7102 ML**

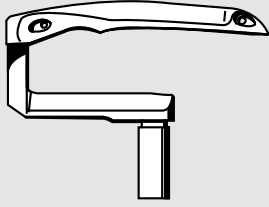

19-351

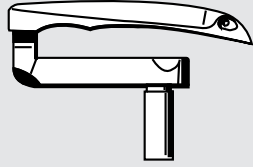

19-353

**DFB  
BX**



19-431



19-437



05-429

**DLR**

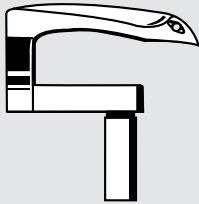

19-512

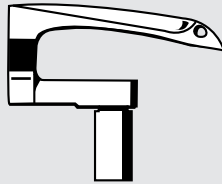

19-514

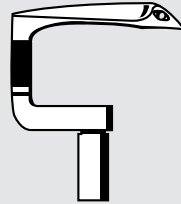

19-518

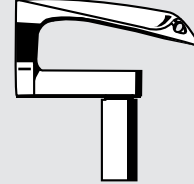

19-521

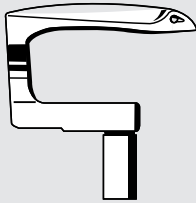

19-522

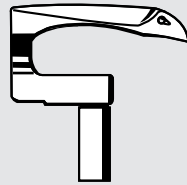

19-546

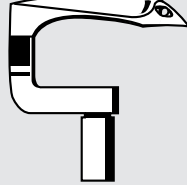

19-547

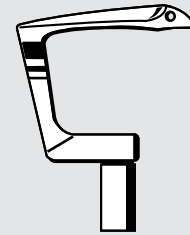

19-548

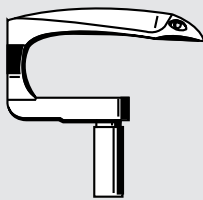

19-535

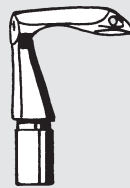

19-581



19-582

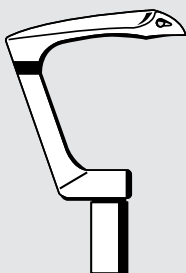

19-549



19-583

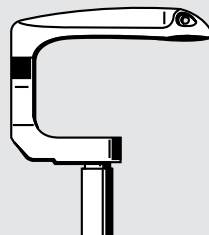

19-536

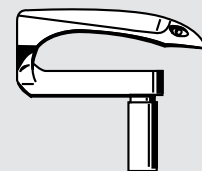

19-531



DVK 1700  
DVK 3200

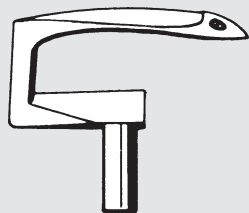

19-703-0

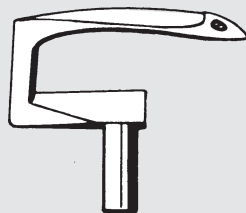

19-712

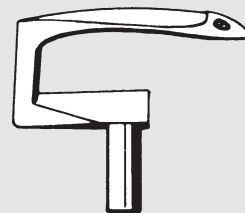

19-713



07-406 (CT)



07-124 (CT)



07-206

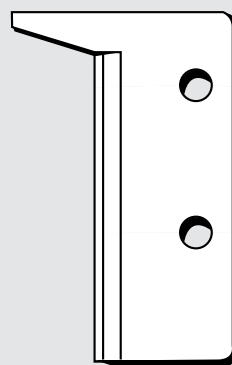

52-275



52-288

DVK 1700  
DVKB-2000  
BLX 2200



07-702 (CT)



07-703 (CT)



07-707

W 8100



07-168  
07-170



07-169



**W 8002, 8003, 8103**  
**V Series**  
**VW Series**

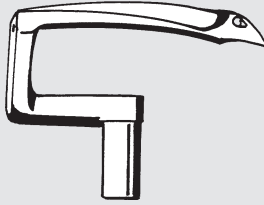

19-801



19-807

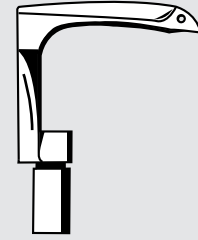

19-810

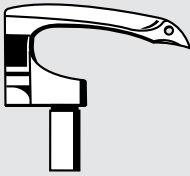

19-811

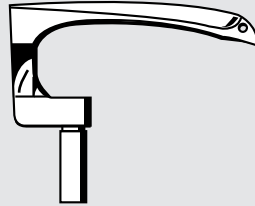

19-814

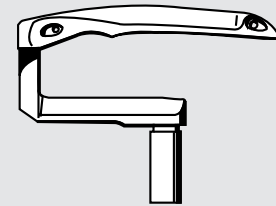

19-351

**WX, LX, MC 30**

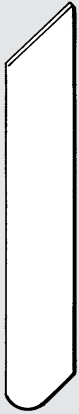

07-558

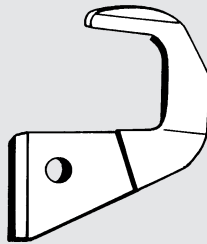

07-570 (CT)



07-507

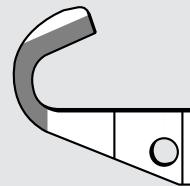

07-505 (CT)



05-812



05-658

**RX-, WX-, BLX Series**

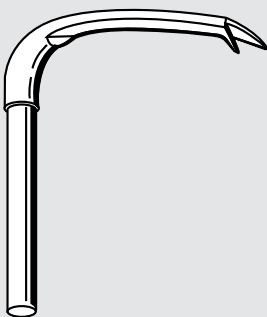

19-505

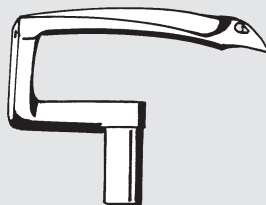

19-539

**DX-, RX Series**  
**MZ Series**

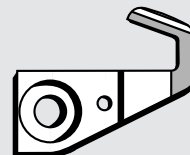

07-544

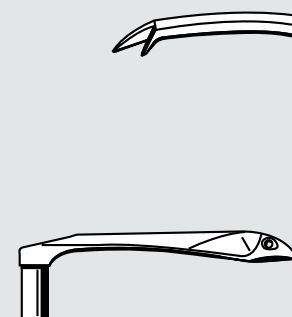

19-525

19-505



**SH-6000 Series  
(Global, Pfaff, Singer usw.)**



377462 (CT)  
6031314 C 500



344559 (CT)

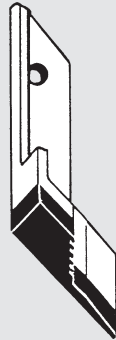

377465 (CT)



377559 (CT)  
G 6050113 C 500

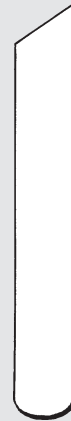

377443  
6031218 P 700



377560  
G 6050114 P 700

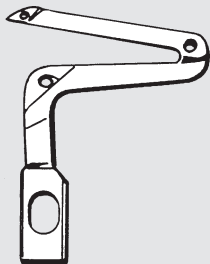

377602  
LL 603884

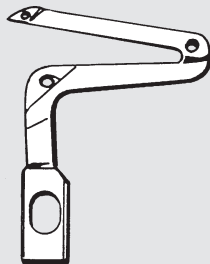

377640  
LL 604885

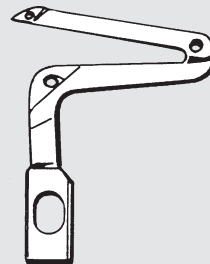

377641  
LL 604884  
LL 600884

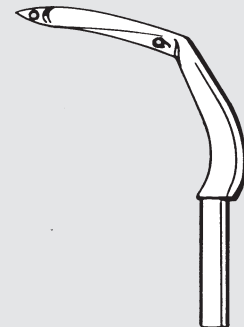

UL 605294

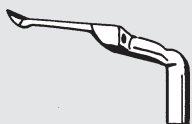

377600 (A)  
UL 603880  
UL 600880

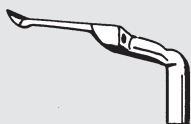

377601 (C)  
UL 603886  
UL 600886

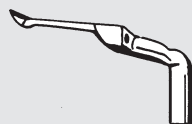

377638 (D)  
UL 604883  
UL 600883

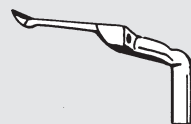

377639 (F)  
GUL 604152

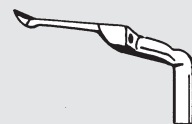

377740 (B)  
UL 603881  
UL 600881



Ersatzteile  
aus eigener  
Herstellung

Teile passend für  
Mauser-Nähmaschinen

### Baureihe 10, 40, 50

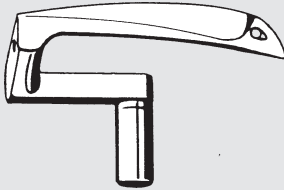

96-712082-05  
Kl. 10, 50



96-705142-05

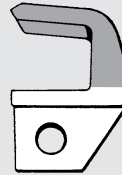

CT 705142



96-700591-05 (HSS)  
CS 816



CT 700591



96-700535-05 (HSS)  
ZA 815



CT 700535



96-701080-05

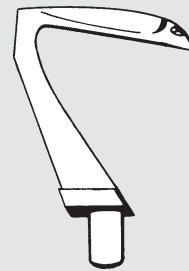

96-700565-05  
CS 37  
Kl. 40

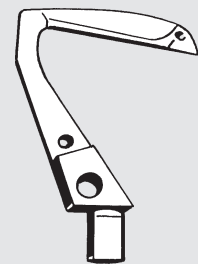

96-722820-05  
Kl. 40

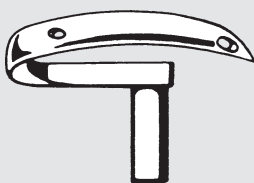

96-702750-05  
AP 37 B

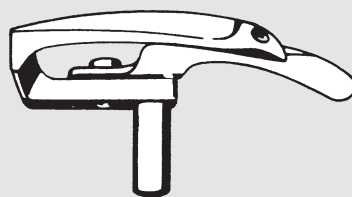

96-702417-91  
AH 37 E

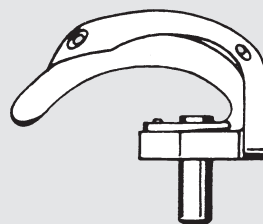

96-706509-05  
CHG 37

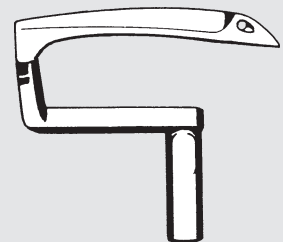

96-710414-05  
F 23100-37 A





**OAH, ODA usw.**

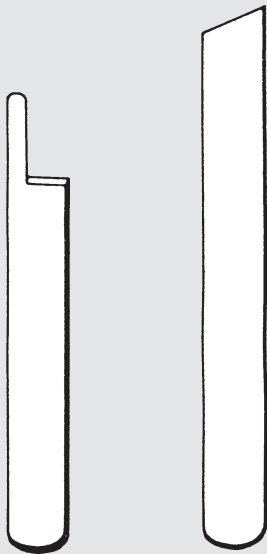

96-705205-05  
JABD 816



96-706135-05  
JABD 815



96-707786-05  
JAB 816 A



JC 816



96-706651-05  
JA 815



96-705438-05  
JAB-A 816

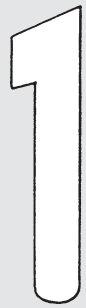

96-705468-05  
JAB-A 815

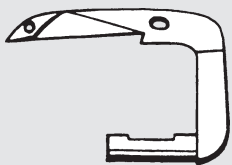

96-702693-05  
J 37 L

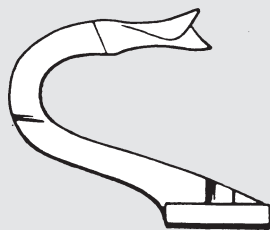

96-702414-05  
JLB 37 R

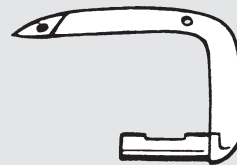

96-702692-05  
JC 37 L

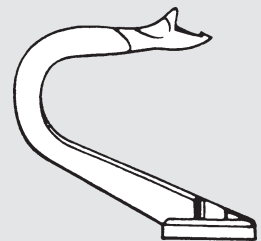

96-702684-05  
JG 37 R

**4542, 4562**

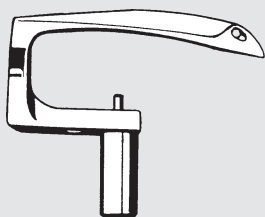

257550-91  
09-400401-00

**68**



96-795104-00



Teile für Mauser-Overlock / Safety-Maschinen siehe Pegasus.  
Parts for Mauser-Overlock / Safety Machines see Pegasus.  
Piezas para Mauser-Overlock / Máquinas de seguridad véase Pegasus.

Mauser-Klasse	=	Pegasus-Klasse	Mauser-Klasse	=	Pegasus-Klasse
401	=	L 22	4762	=	W 762
500	=	L	9622	=	E 22
504	=	R 53, R 57	9622 L	=	E 22 L
2001	=	S 22	9632	=	E 32
2003	=	S 52	9632 L	=	E 32 L
2004	=	S 52	9651	=	E 51
2005	=	S 52	9652	=	E 52
2014	=	S 32	9652 L	=	E 52 L
2015	=	S 32	9654 A	=	E 54
2016	=	S 32	9656	=	E 256
4542	=	W 542	9732	=	ETS 32
4562	=	W 562	9732 L	=	ETS 32 L
4664	=	W 664	9751	=	ETS 51
4742	=	W 742	9752	=	ETS 52

### S 1323 usw.



96-720745-05  
S 815-8  
720745 (CT)

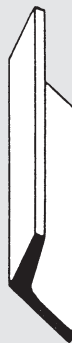

96-720742-05  
SH 816-8

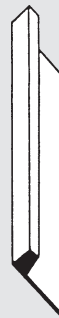

96-720744-05  
SK 816

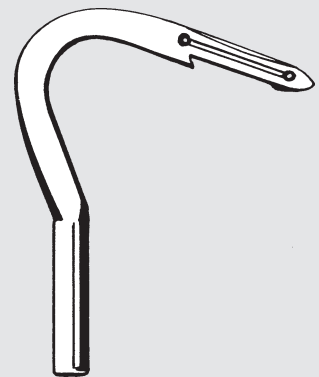

96-720392-05  
S 37 BL

### AG



CAM 315



CAM 316



CT 6-90 D



A-90-1

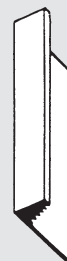

A 90-3



6-91



6-91 E



CT 6-91 E



6-91 C



6-91 H



6-91 K



59



69



72



**DB 130, 189, 199**  
**LS 2-150, 180**  
**LS 190, 210**



MF 16 A 0838

**LG 2-3370, LS-1280**  
**LS 2-180, LS 2-190, LS 2-210**  
**LS 2-1180, LS 2-1280, LS 2-1380, LS 2-1780**  
**LS 2-2210**

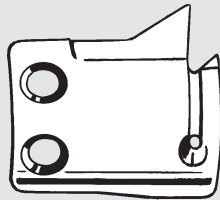

MF 00 A 0834



MF 00 A 0838



MN 35 A 0838

**DB-199, LS 2-190**  
**PLK-1210, PLK-2520**

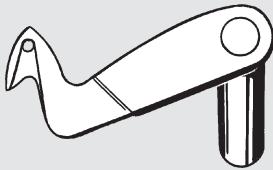

MF 90 B 2838  
MF 90 B 0838

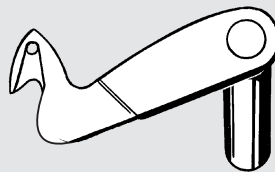

MG 44 B 0838

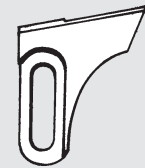

MF 90 A 0838

**109, 303**



MS 01 B 0838

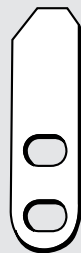

MS 01 A 0838

**DB 189**

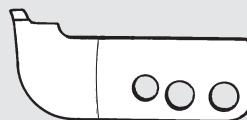

MF 40 A 1835  
MF 40 A 2835

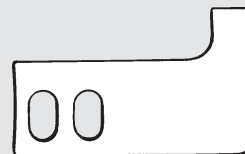

MF 40 A 1834

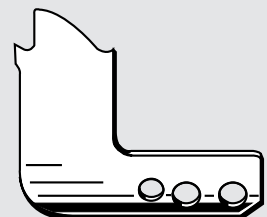

MF 40 A 2180



LS 2-Series  
LT 2-Series  
LU 2-Series  
LU-Series

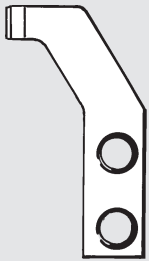

MN 50 A 0838



MN 50 B 0838



MP 41 A 0838

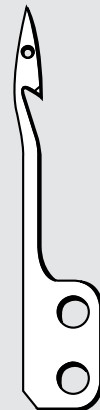

MP 41 B 0838

DY 359  
PLK-2520 A  
LY-3310-B1T  
LY-3750-B1T  
LY2-3710-B1T  
LY1-3750-B1T

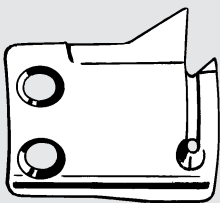

MG 52 A 0834



MG 52 A 0838

339, 349



MG 40 B 0834

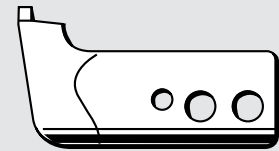

MG 40 B 0835

PLK-Series  
PLK-E-Series  
PLK-G-Series



MS 03 B 0838



MS 03 A 0838  
MS 14 A 0838

LS 2-180 B1T  
PLK-1410, 1710  
PLK-E 2010R  
PLK-E 2516R

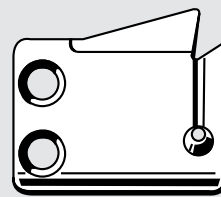

MF 02 A 0834



MF 02 A 0838  
MS 10 A 0838



**400-100, 405-100, 458-100**

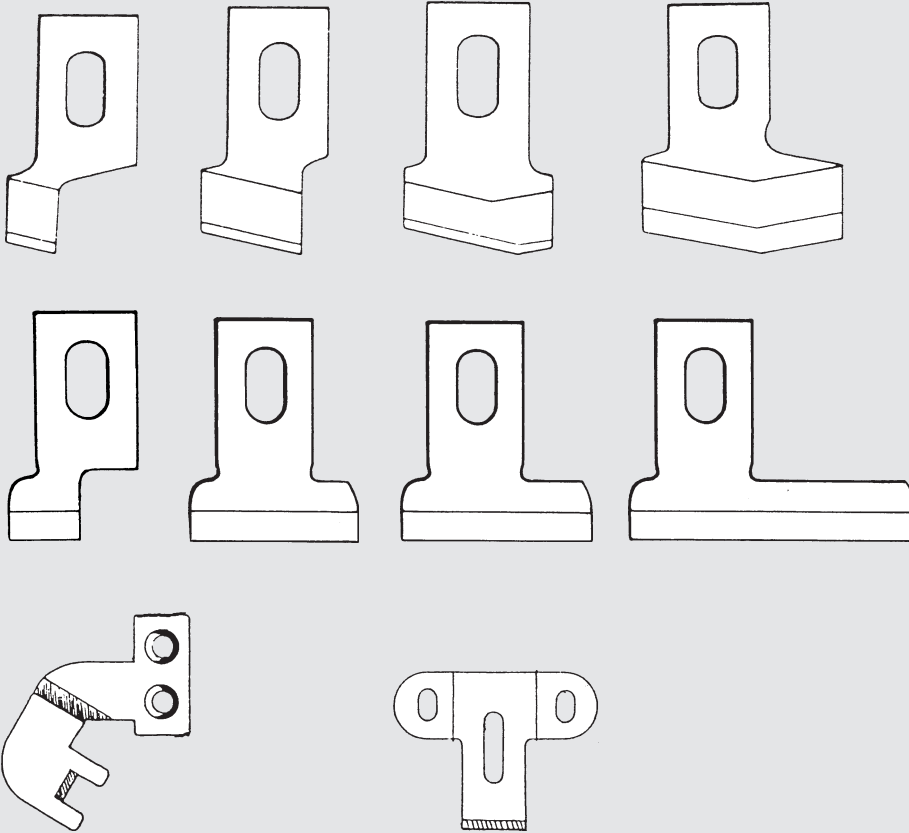

154851000

154852000

**HSS = High speed steel  
Acero rápido de  
alto rendimiento**

	= Pfaff-No.
996448000	= 20241 - 6,4
996449000	= 20241 - 9,5
	= 20241 - 11,0
996450000	= 20241 - 12,7
	= 20241 - 14,0
996451000	= 20241 - 16,0
	= 20241 - 17,5
996452000	= 20241 - 19,0
	= 20241 - 20,0
996453000	= 20241 - 22,2
996454000	= 20241 - 25,4
996455000	= 20241 - 28,6
996456000	= 20241 - 31,7
	= 20241 - 33,3
	= 20241 - 36,5
996458000	= 20241 - 38,1
	= 20241 - 39,7

120748 - 6,4
120748 - 9,5
120748 - 11
120748 - 12,7
120748 - 14
120748 - 16
120748 - 17,5
120748 - 19
120748 - 22,2
120748 - 25,4

**835-261, 263  
885-261, 263  
UAN 2641 / 2661**

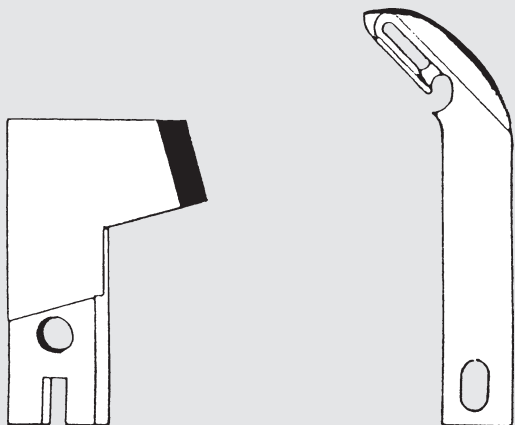

186188202 (CT)

186185007

**UAN 1700, 1701**

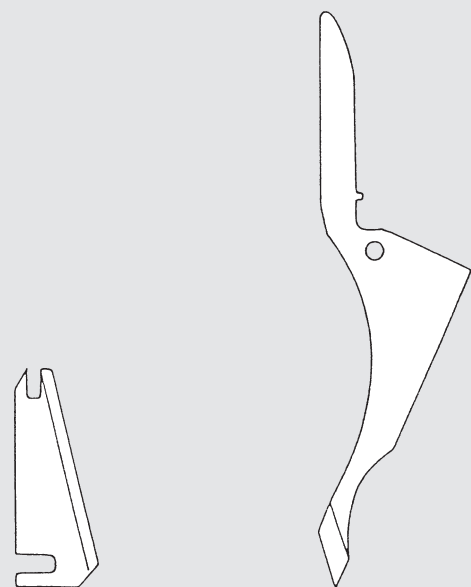

181814003

181812000 (HSS)



**DCR 601, 801, 901, 905**  
**E22, E22L, E32, E32L, E51, E52, E52L, E54, E256**  
**ETS32, ETS32L, ETS51, ETS52**  
**EX/EXT 3200, 5100, 5200, 5400 Series**

**L32, L52**  
**R53, R57**  
**S22, S32, S52**  
**W&G 504, 515**

**MX 3200, 5200**  
**LX 3200, 5200**  
**M 600, M 700**  
**BL 500, BL 600**



202570  
323-870-200  
09-009052-54



201121 A  
323-870-214  
09-009050-06 (CT)



205607 (CT)  
09-009801-41  
links/lefthand/  
à la izquierda



205890 (CT)  
09-009732-15



202571  
323-870-201  
09-009052-55



202527 (CT)  
323-870-207  
09-009070-82



277000 (CT)  
09-009846-02



210755



CT 210755  
91-179421-01

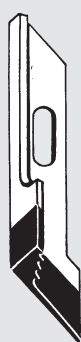

211771 (CT)  
09-009807-78

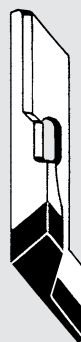

211662 (CT)  
09-009802-00

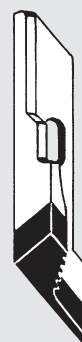

211662A (CT)  
09-009857-11

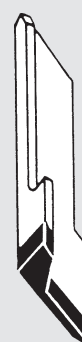

204835 (CT)  
09-009071-09

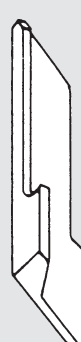

204152  
09-009065-29



202295  
323-870-210  
09-009-066-42



202572  
323-870-202



205609  
09-009801-40  
links/lefthand/  
à la izquierda



202893  
323-870-215  
09-009819-09 (CT)



201127  
323-870-211  
09-009054-43  
202573  
323-870-203  
09-009052-57



DCR 601, 801, 901, 905  
E22, E22L, E32, E32L, E51, E52, E52L, E54, E256  
ETS32, ETS32L, ETS51, ETS52  
EX/EXT 3200, 5100, 5200, 5400 Series

L32, L52  
R53, R57  
S22, S32, S52  
W&G 504, 515

MX 3200, 5200  
LX 3200, 5200  
M 600, M 700  
BL 500, BL 600



204161  
323-870-213  
09-009053-33



204351  
323-870-218  
09-009606-90 (CT)



204161 A  
09-009831-32



211661  
09-009803-45



210762  
09-009620-39



277009  
09-009846-08



208393  
09-009842-89

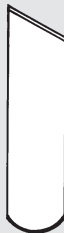

213108  
09-009812-97

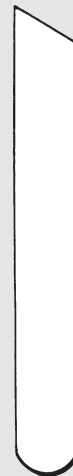

211742  
09-009825-62



211788  
09-009806-67

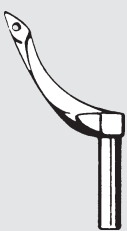

202874 (1)  
323-810-211  
09-009053-31



204062 (2)  
323-810-218  
09-009054-19

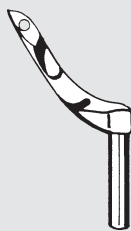

202828 (4)  
323-810-224  
09-009065-90



204663 (7)  
323-810-008  
09-009068-07



204990 (12)  
323-810-231  
09-009603-48

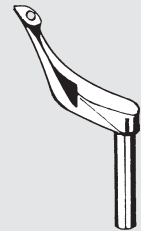

204702 (4)  
323-810-009  
09-009067-70





**DCR 601, 801, 901, 905**  
E22, E22L, E32, E32L, E51, E52, E52L, E54, E256  
ETS32, ETS32L, ETS51, ETS52  
EX/EXT 3200, 5100, 5200, 5400 Series

**L32, L52**  
R53, R57  
S22, S32, S52  
W&G 504, 515

**MX 3200, 5200**  
LX 3200, 5200  
M 600, M 700  
BL 500, BL 600

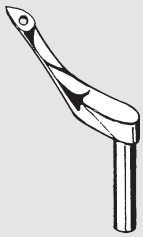

204703 (6)  
323-810-010  
09-009067-68



204704 (3)  
323-810-011  
09-009068-98



204705 (5)  
323-810-012  
09-009067-69

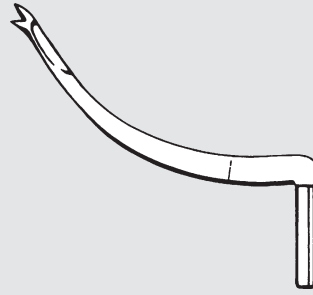

201234 A  
323-810-003  
09-009050-62

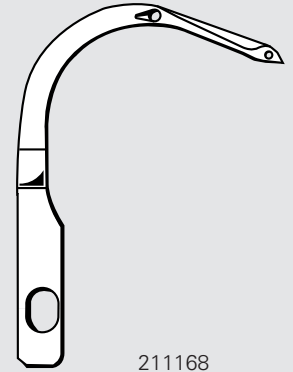

211168

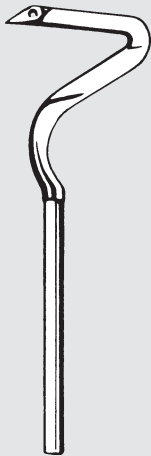

201085 B  
323-810-002  
09-009049-56

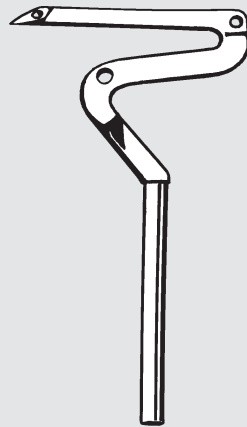

202703  
09-009065-89

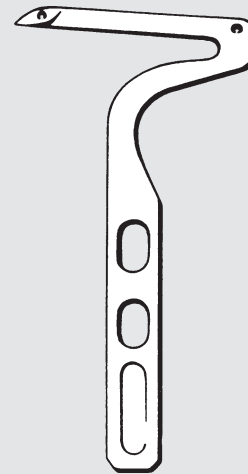

204072  
323-810-216  
09-009054-20

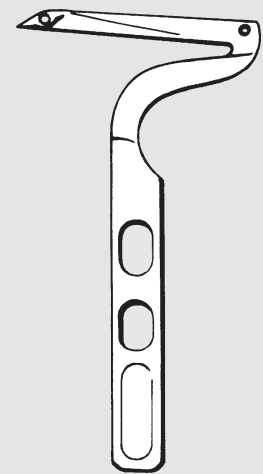

204991  
323-810-232  
09-009603-49

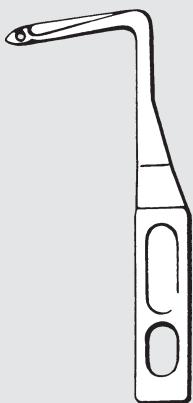

204314 A  
323-810-217  
09-009065-25

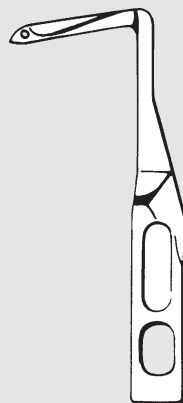

204431  
323-810-219  
09-009065-26

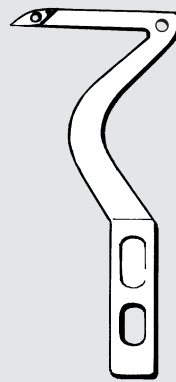

210354  
323-810-018  
09-009618-12

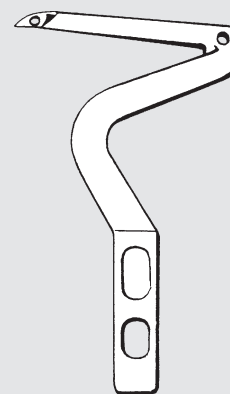

210356  
323-810-019  
09-009615-99

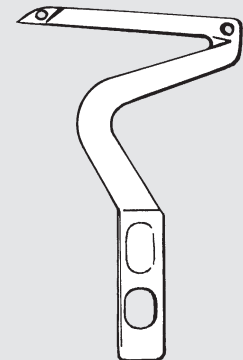

211651  
09-009802-29



**DCR 601, 801, 901, 905**  
**E22, E22L, E32, E32L, E51, E52, E52L, E54, E256**  
**ETS32, ETS32L, ETS51, ETS52**  
**EX/EXT 3200, 5100, 5200, 5400 Series**

**L32, L52**  
**R53, R57**  
**S22, S32, S52**  
**W&G 504, 515**

**MX 3200, 5200**  
**LX 3200, 5200**  
**M 600, M 700**  
**BL 500, BL 600**

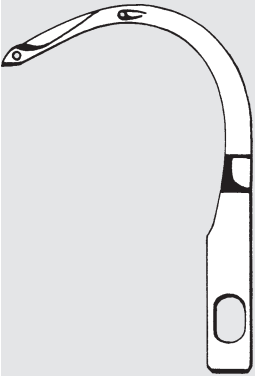

210357  
09-009807-47

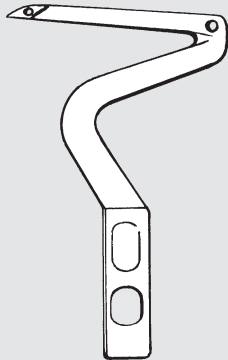

212215  
09-009802-28

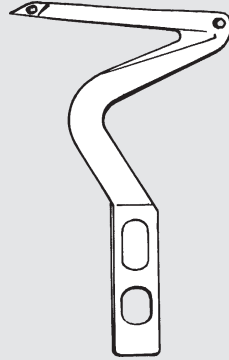

212644  
09-009804-51

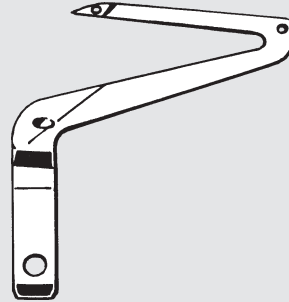

213105  
09-009812-96

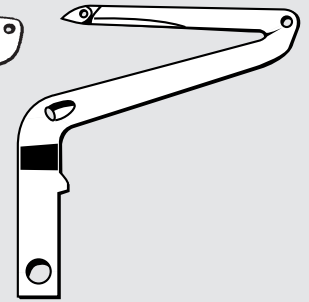

277021



210358 (2)  
323-810-021  
09-009620-31



210359 (4)  
323-810-022  
09-009616-01



210360 (6)  
323-810-023  
09-009618-08



210364 (22)  
323-810-025  
09-009616-03



210365 (24)  
323-810-026  
09-009616-04



210366 (26)  
323-810-027  
09-009620-33



210367 (28)  
09-009620-34



210729 (30)  
323-810-031  
09-009617-97



210730 (32)  
09-009617-98



211719 (38)  
09-009733-31



211720 (40)  
09-009802-26



210512 (21)  
09-009617-06

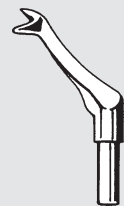

210513 (23)  
09-009617-07



211845 (29)  
09-009733-37



212092 (10)  
09-009811-92



204949 (11)  
09-009833-45



204963 (8)  
09-009611-28



204964 (9)  
09-009611-29



**DCR 601, 801, 901, 905**  
**E22, E22L, E32, E32L, E51, E52, E52L, E54, E256**  
**ETS32, ETS32L, ETS51, ETS52**  
**EX/EXT 3200, 5100, 5200, 5400 Series**

**L32, L52**  
**R53, R57**  
**S22, S32, S52**  
**W&G 504, 515**

**MX 3200, 5200**  
**LX 3200, 5200**  
**M 600, M 700**  
**BL 500, BL 600**

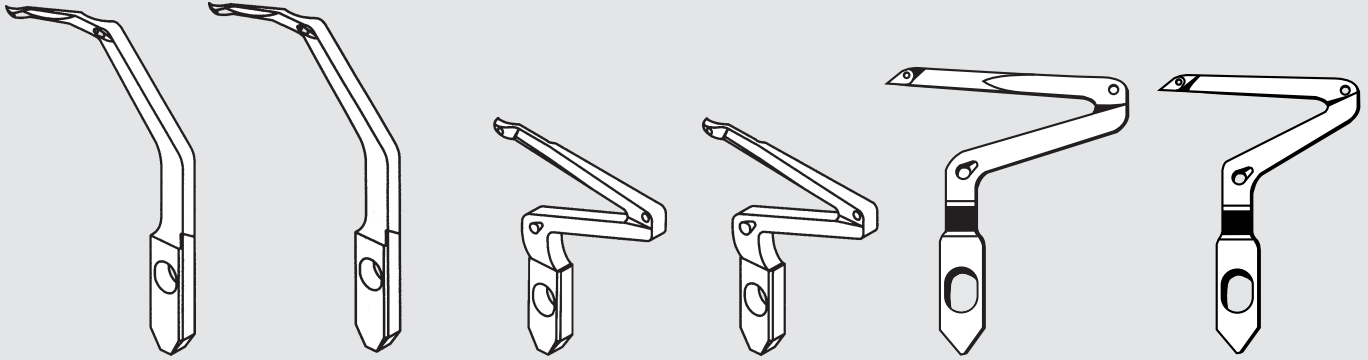

277018 09-009846-18    277018 C 09-009846-19    277015 09-009846-14    277015 A 09-009846-15    277016 A    277034

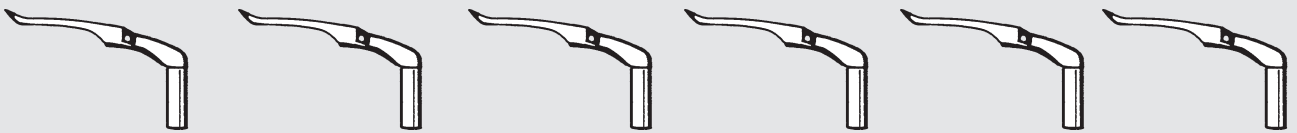

277010 (2) 09-009846-09    277010 A (5) 09-009846-10    277010 B    277011 (3) 09-009846-11    277012    277013



277014 (1) 09-009846-12    277014 A (8) 09-009846-13    277014 B (9) 09-009844-22    277017 (11) 09-009846-17    277019 (12) 09-009846-20

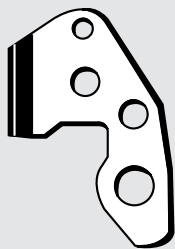

308030 (CT)

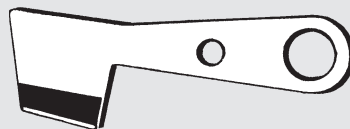

301008 09-009621-65 (CT)

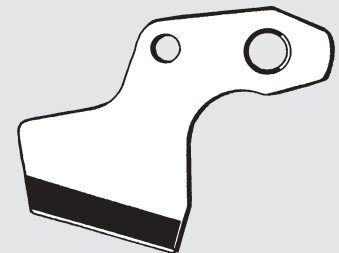

301036 09-009806-73 (CT)

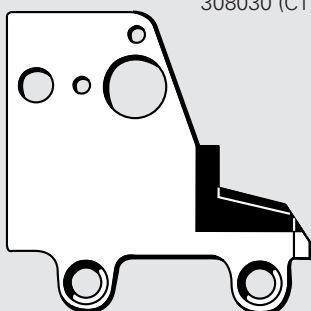

308026-91 (CT)

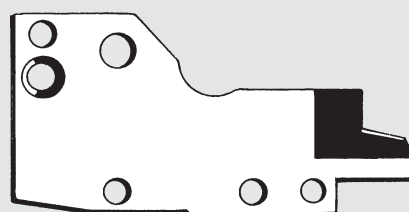

301006 09-009621-64 (CT)

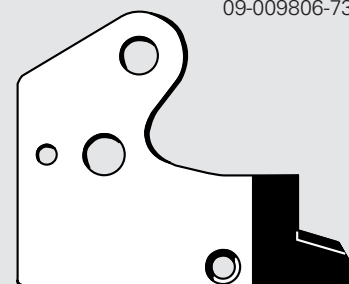

179458-05 (CT)



DCR 601, 801, 901, 905  
E22, E22L, E32, E32L, E51, E52, E52L, E54, E256  
ETS32, ETS32L, ETS51, ETS52  
EX/EXT 3200, 5100, 5200, 5400 Series

L32, L52  
R53, R57  
S22, S32, S52  
W&G 504, 515

MX 3200, 5200  
LX 3200, 5200  
M 600, M 700  
BL 500, BL 600

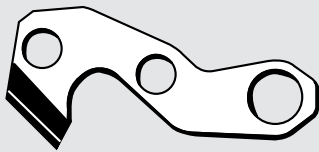

179459-05 (CT)

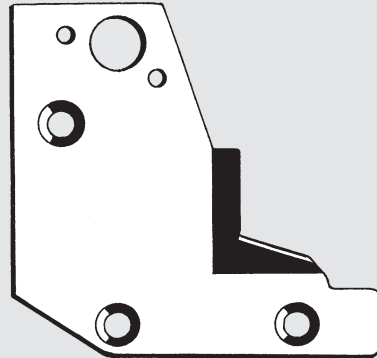

301035  
09-009806-72 (CT)

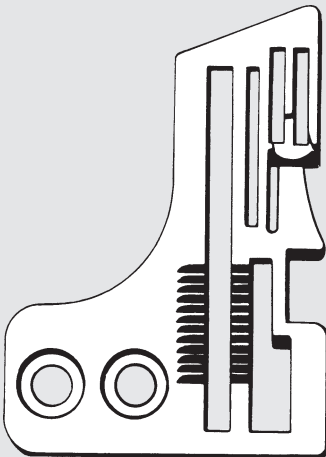

205322  
09-009070-90

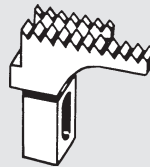

208336  
09-009611-68

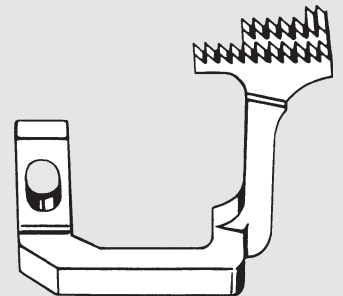

204907  
09-009068-97



208338  
09-009611-70

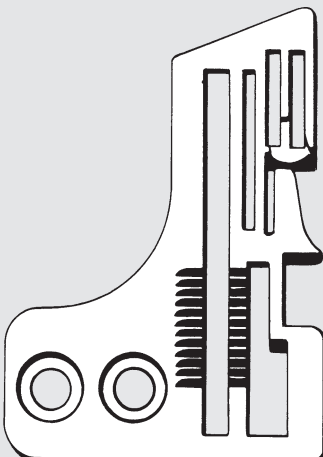

205321  
09-009611-37

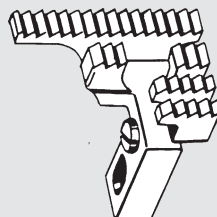

208063  
09-009071-19

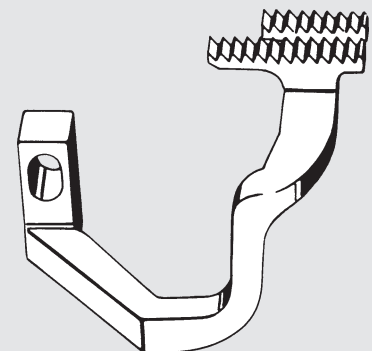

208215  
09-009071-27



**DCR 601, 801, 901, 905**  
**E22, E22L, E32, E32L, E51, E52, E52L, E54, E256**  
**ETS32, ETS32L, ETS51, ETS52**  
**EX/EXT 3200, 5100, 5200, 5400 Series**

**L32, L52**  
**R53, R57**  
**S22, S32, S52**  
**W&G 504, 515**

**MX 3200, 5200**  
**LX 3200, 5200**  
**M 600, M 700**  
**BL 500, BL 600**

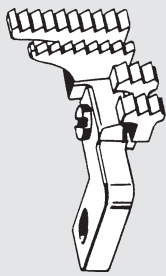

210568  
09-009617-26

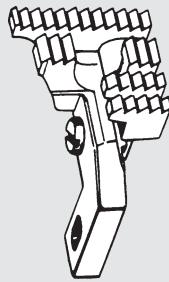

210581  
09-009606-75

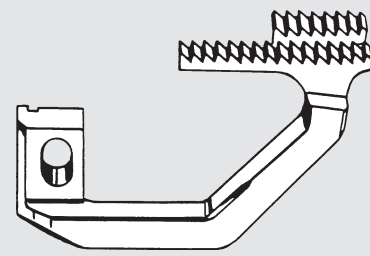

210494  
09-009616-98

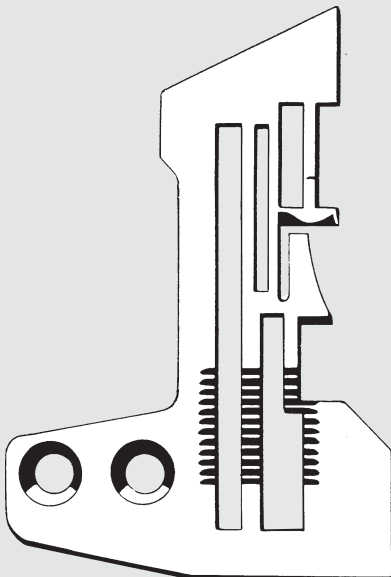

210787  
09-009620-45

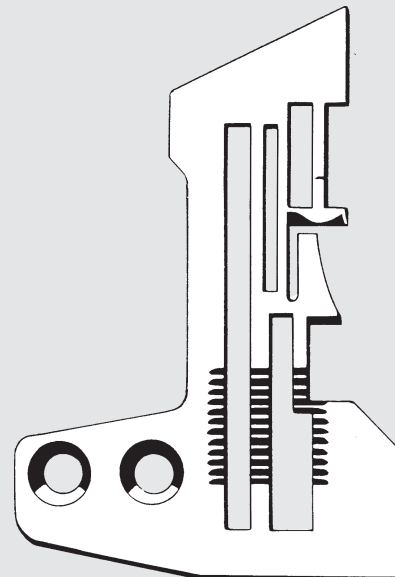

210788  
09-009620-46



**DCR 601, 801, 901, 905**  
E22, E22L, E32, E32L, E51, E52, E52L, E54, E256  
ETS32, ETS32L, ETS51, ETS52  
EX/EXT 3200, 5100, 5200, 5400 Series

**L32, L52**  
R53, R57  
S22, S32, S52  
W&G 504, 515

**MX 3200, 5200**  
LX 3200, 5200  
M 600, M 700  
BL 500, BL 600

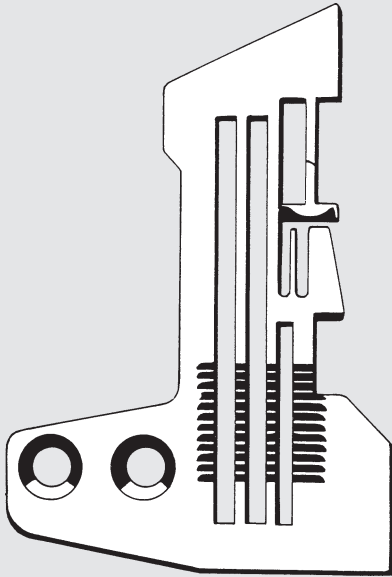

210810  
09-009620-66

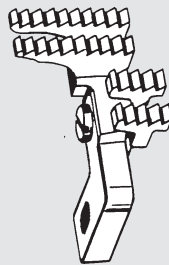

210575  
09-009617-33

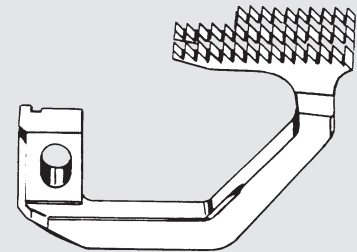

210445  
09-009616-58

**TM 625**

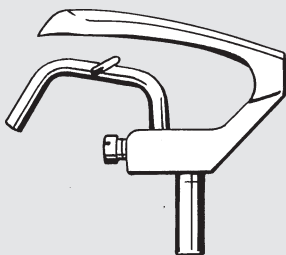

188004

**M 732**

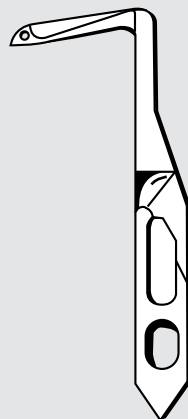

209685

**DCM 203, DCM 220, 230**



138559  
09-009048-49



137562  
09-009048-39



**W 280-, 500-, 600-, 700-, 1500-, 2600 Series**  
**WT 200-, 600 Series**

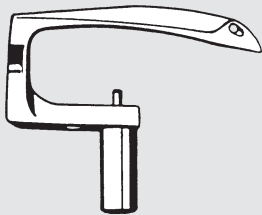

257550-91  
09-400401-00

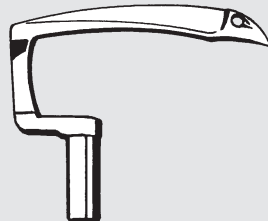

257555  
09-009854-48



350018-91  
(CT)



350024

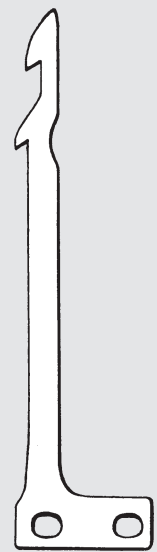

350220  
09-009825-63

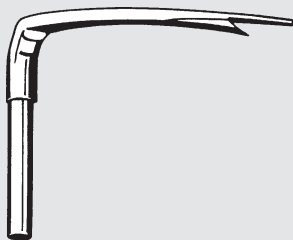

257552  
09-400404-00

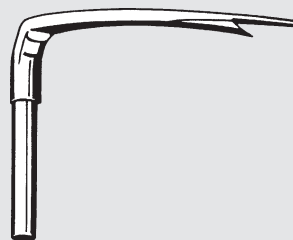

257565  
09-009826-28



257566  
09-009826-26



350218  
09-009825-64

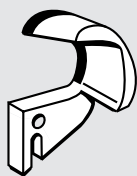

257573 (CT)

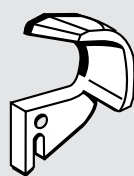

257573 A (CT)



306394 (CT)  
09-400427-00



257574 (CT)

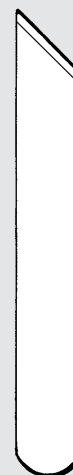

204161  
09-009053-33

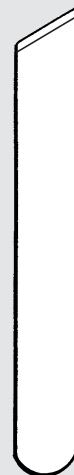

204161 A  
09-009831-32



**FS, FV, FW Series**

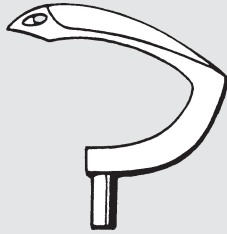

236504 A  
09-009852-28



236502 A  
09-009852-26

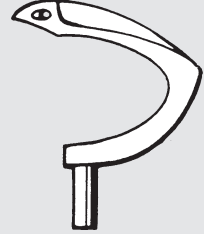

236503 A  
09-009852-27

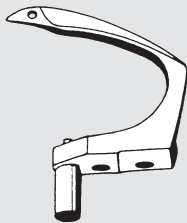

236500 A  
09-009854-55

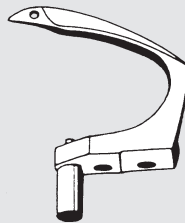

236500  
09-009854-54

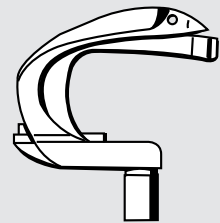

236501 A

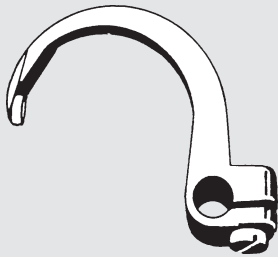

236610



236101  
09-009854-49



236609  
09-009854-56



236618



236606 SUPER  
09-009854-52



236608 SUPER  
09-009854-53





133, 134



15323



- 15320-2,0
- 15320-2,5
- 15320-3,0
- 15320-3,5
- 15320-4,0
- 15320-4,5
- 15320-5,0
- CT 15320-3,0
- CT 15320-3,5
- CT 15320-4,0
- CT 15320-4,5
- CT 15320-5,0
- CT 15320-6,0

141, 143



19506 x 5,0



19506 x 7,0



19506 x 9,0

142, 242, 244, 1242, 1243, 1244



113460



10192



91-048908-10-30

91-048909-93/001 (CT)

151, 153



15435 x 4,0  
15435 x 5,0

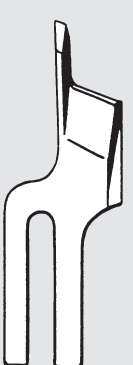

15435 x 7,0

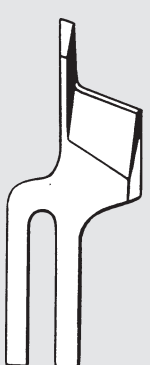

15435 x 9,0

155, 175, 194, 294,  
1293, 1294, 1295, 1296, 3713



19737 x 5,0



19737 x 7,0



19737 x 9,0



Ersatzteile  
aus eigener  
Herstellung

**Teile passend für  
Pfaff-Nähmaschinen**

**143, 191, 193  
471, 474, 491, 493, 571, 574, 591  
1471, 1474, 1491, 1493, 1494  
1571, 1574, 1591**

**2571, 2574, 2591  
3734-2/01, /21  
3834-4/11, /21**

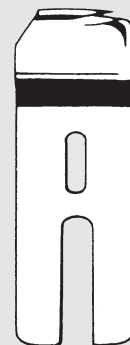
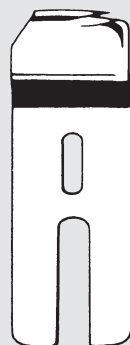
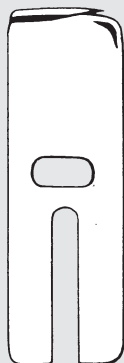
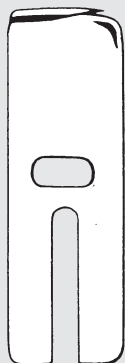

91-011165-04/001 = 2,7  
91-011165-04/002 = 3,0  
91-011165-04/003 = 3,5  
91-011165 F x 2,7

91-011165-04/011 = 2,7 (HSS)  
91-011165-04/013 = 3,5 (HSS)

91-011233-04/001 = 2,7

91-011233-04/011 = 2,7 (HSS)

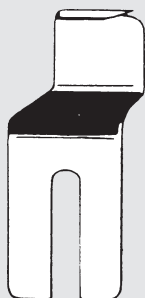

91-011179-04/001 = 2,7  
91-011179-04/003 = 3,5

91-011179-04/011 = 2,7 (HSS)

91-011324-04/001 = 2,7  
91-011324-04/002 = 3,1  
91-011324-04/003 = 3,5

91-011324-04/011 = 2,7 (HSS)  
91-011324-04/013 = 3,5 (HSS)



91-119202-04/001

91-119202-04/011 (HSS)

91-119444-04/001

91-119444-04/011 (HSS)

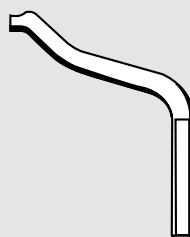
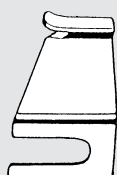

91-119714-05

91-119715-05

91-156114-05

91-175952-05  
Kl. 493-755-743-04



**143, 191, 193  
471, 474, 491, 493, 571, 574, 591  
1471, 1474, 1491, 1493, 1494  
1571, 1574, 1591**

**2571, 2574, 2591  
3734-2/01, /21  
3834-4/11, /21**

91-119283-01

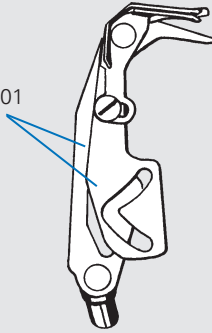

91-119486-91

91-164673-01

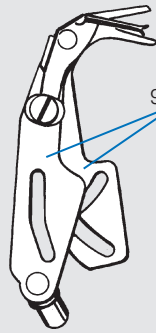

91-164672-91



91-119455-05



91-058309-1,2A x 4,5



91-150526-04/001  
Bx5,0



91-150868-24/002  
BN5



91-150739-24/001  
Bx5,0

**194-900, 1293**



91-011957-15

**333, 335, 337**



91-014046-05

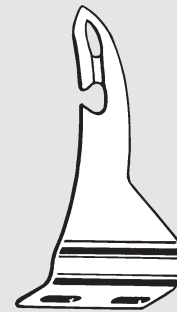

91-165505-05  
91-175540-05

**441, 442**

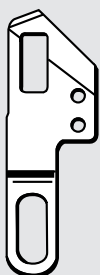

91-173197-15

**5463, 5467  
5483, 5487, 5489  
3801, 3806, 3811, 3832**

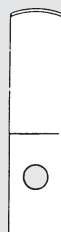

91-172071-05  
91-172358-05



91-054896-05

**540**



91-018147-05



Ersatzteile  
aus eigener  
Herstellung

**Teile passend für  
Pfaff-Nähmaschinen**

**421, 422, 441, 521, 1521, 1525, 1526  
1421, 1422, 1425, 1426, 1446  
3587, 3588, 3590  
3715**

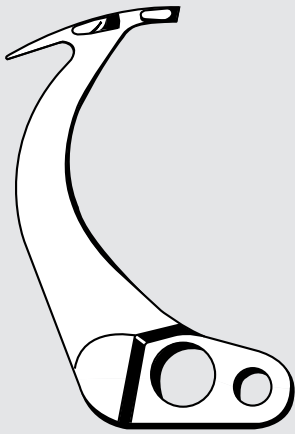

91-164925-05

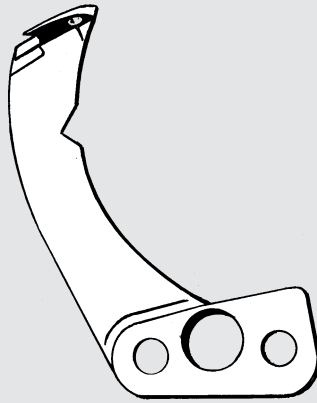

91-176357-05

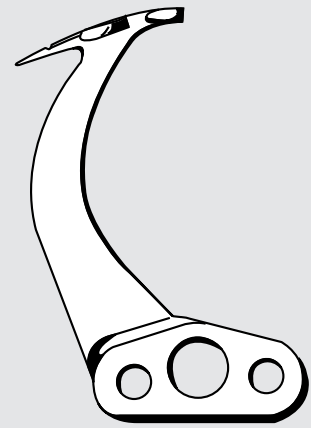

91-176094-05

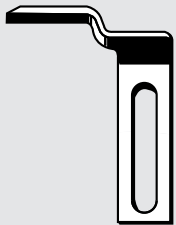

91-176098-05

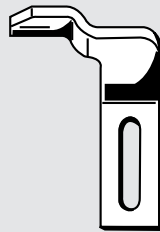

91-186659-05



91-166700-04/001 (x 7)



91-166700-04/002 (x 9)



91-166700-04/003 (x 12)



91-186661-05

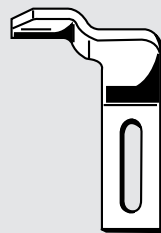

91-266584-05

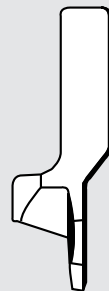

91-166701-04/004 (x 7)



91-166701-04/005 (x 9)

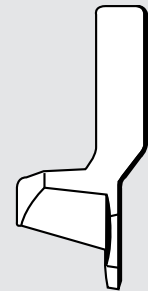

91-166701-04/006 (x 12)



**3548, 5642, 5645, 5646**

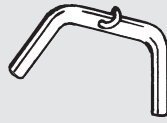

91-172802-01



91-173792-05 x 7,0

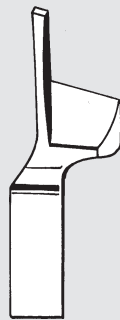

91-173792-05 x 9,0



91-178926-05

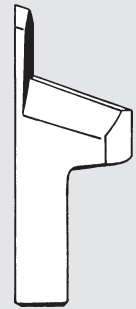

91-177919-05

**418, 437, 438, 439  
917, 918, 919, 937, 938, 939  
2438, 3568, 3704, 4238  
KSM 200  
918U, 938U, 939U**

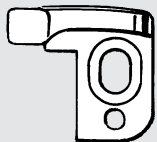

91-167973-05

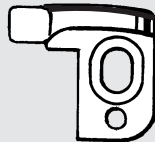

91-167350-01 (CT)



91-168498-15



91-168499-05



91-150166-05  
solid carbide  
metal solide duro



91-150446-05  
solid carbide  
metal solide duro

**3306, 3307, 3860**



91-132558-05



91-110482-05



91-180295-05



Ersatzteile  
aus eigener  
Herstellung

**Teile passend für  
Pfaff-Nähmaschinen**

**461, 463, 469  
481, 483, 487, 489  
1051, 1053  
1181, 1183**

**1481, 1483, 1487, 2481, 2483  
5463, 5483, 5489  
3566, 3568, 3586, 3588  
3819, 3822, 3827**

**951, 953  
563**

**3511, 3701  
3519, 9083**



69595 x 5,0 (HSS)



69595 x 7,0 (HSS)  
CT = 69596 x 7,0



69595 x 9,0 (HSS)  
CT = 69596 x 9,0



069596 x 7,0 (CT)  
069596 x 9,0 (CT)



169395 x 5,0 (HSS)



169395 x 7,0 (HSS)



CT 169395 x 7,0



169395 x 9,0 (HSS)



CT 169395 x 9,0



91-170440-05



91-170560-04/002 x (7,0)



91-170560-04/003 x (9,0)



91-265118-05  
KI. 3822-1/24



91-189140-05

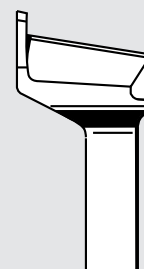

91-165629-05



461, 463, 469  
481, 483, 487, 489  
1051, 1053  
1181, 1183



91-171853-15/000

1481, 1483, 1487, 2481, 2483  
5463, 5483, 5489  
3566, 3568, 3586, 3588  
3819, 3822, 3827



91-264338-15



91-165642-15

951, 953  
563



91-169239 x 0,8

3511, 3701  
3519, 9083



91-169239 x 1,0

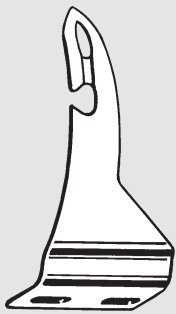

91-165505-05  
91-175540-05

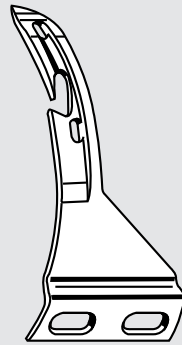

91-165641-05

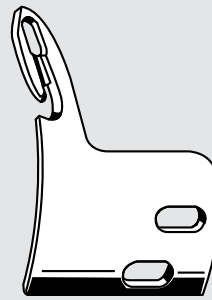

91-262184-05

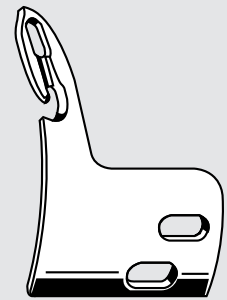

91-264240-05

3334, 3335, 3336, 3337, 3338, 3339

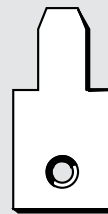

91-182344-05

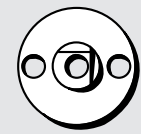

91-065546-05

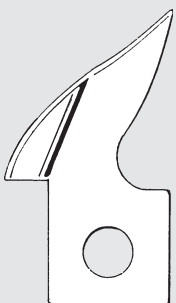

91-022453-05  
91-022097-05

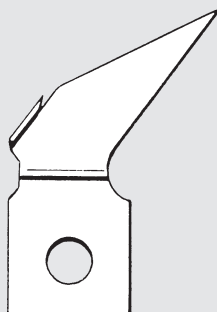

91-022096-05  
91-132168-05



91-130182-05

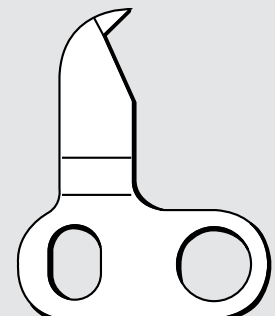

91-130183-05



Ersatzteile  
aus eigener  
Herstellung

Teile passend für  
Pfaff-Nähmaschinen

1114



J101.10.1-2



J101.10.1-7

1163, 9063

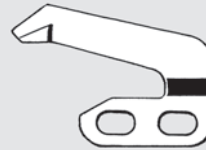

JGR1046-8

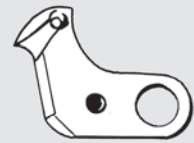

JGR1049/2-8

1122



J211-0060

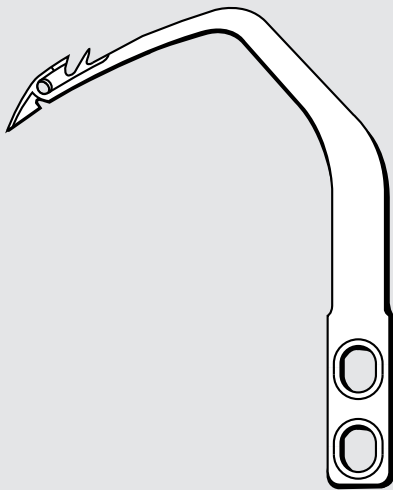

J211.7.7

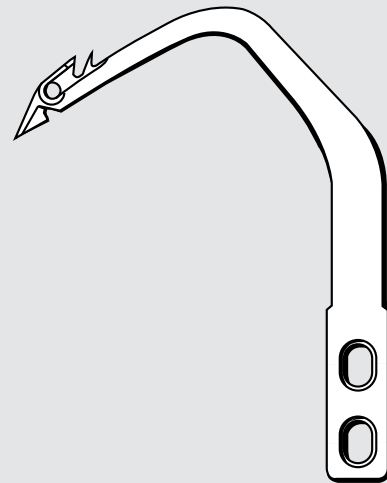

J211-0690

3371

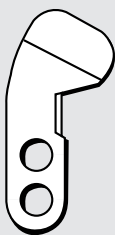

J501GB107

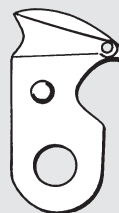

J501BJ133

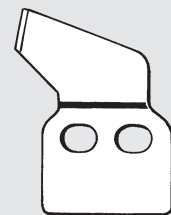

91-181729-05  
J501GB160





5704, 5714, 5716, 5742  
= Pegasus



J202527 A



J201121 A



J202295

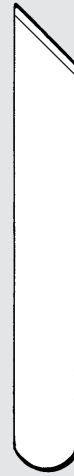

J204161



J208393

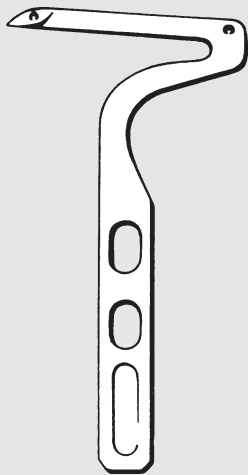

J204072

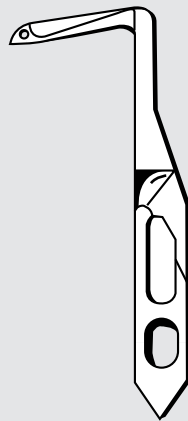

J209685

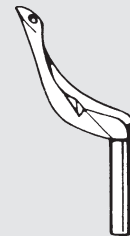

J204062

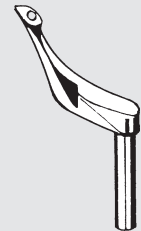

J204702



J204703



J204949

3519

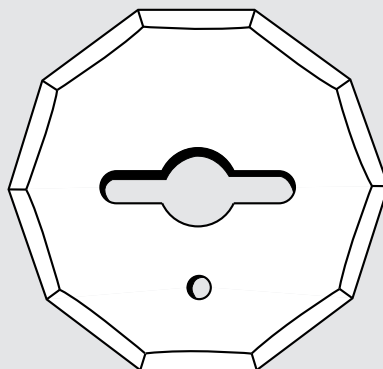

- 99-134505-05
- 99-134505-05 (HSS)
- 99-134505-05 (TIN)



**3114, 3116, 3117, 3119, 3527**

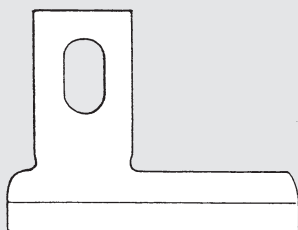
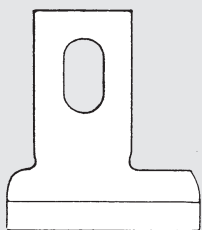
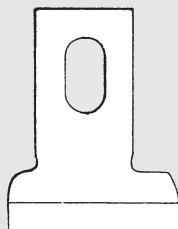
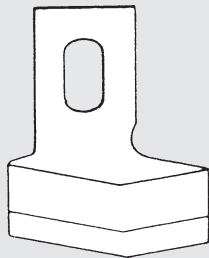
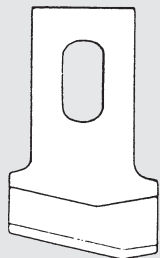
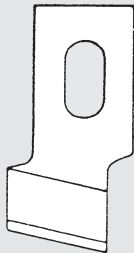
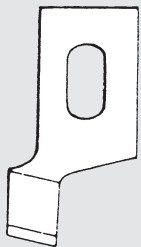

**HSS = High speed steel  
Acero rápido de  
alto rendimiento**

91-020241 - 6,4	91-020241 - 22,2
91-020241 - 9,5	91-020241 - 25,4
91-020241 - 11,0	91-020241 - 28,6
91-020241 - 12,7	91-020241 - 31,7
91-020241 - 14,0	91-020241 - 33,3
91-020241 - 16,0	91-020241 - 36,5
91-020241 - 17,5	91-020241 - 38,1
91-020241 - 19,0	91-020241 - 39,7
91-020241 - 20,0	

91-120748 - 6,4	= 71-90 1/4
91-120748 - 9,5	= 71-90 3/8
91-120748 - 11,0	= 71-90 7/16
91-120748 - 12,7	= 71-90 1/2
91-120748 - 14,0	= 71-90 9/16
91-120748 - 16,0	= 71-90 5/8
91-120748 - 17,5	= 71-90 11/16
91-120748 - 19,0	= 71-90 3/4
91-120748 - 22,2	= 71-90 7/8
91-120748 - 25,4	= 71-90 1
91-120748 - 28,6	= 71-90 1 1/8

**4644, 4661**

**siehe Pegasus W 664  
see Pegasus W664  
véase Pegasus W 664**



**S 2, S 200, S 2000  
S 4000, S 5000**



S 2-51 N  
20-0051-1-024  
left



S 2-51 R  
20-0051-1-024  
center



S 2-51 M  
20-0051-1-024  
right

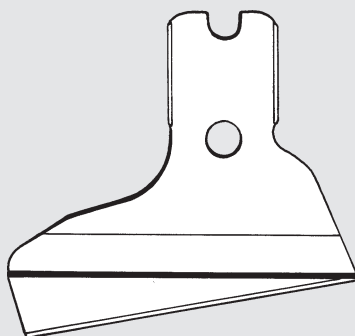

20-0356-0-003 ED

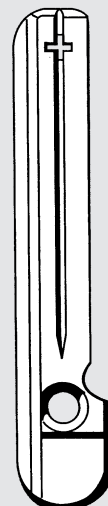

20-0051-0-003



20-0093-2-004



20-0112-0-000  
20-0119-2-000  
S 119-N



20-0111-0-000  
20-0116-3-000  
S 116-N 2



20-0094-1-000



20-0094-0-000

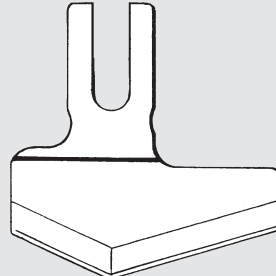
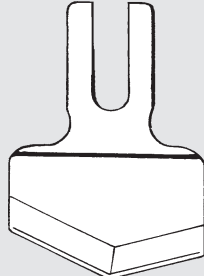
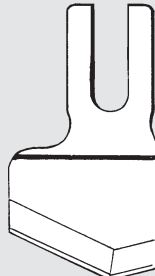
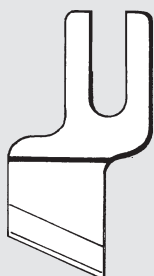

S2:  
20-0356-1-049 bis 060  
S200, S2000:  
23-2356-2-049 bis 060

- 23-2356-2-049 1/4
- 23-2356-2-050 3/8
- 23-2356-2-051 7/16
- 23-2356-2-052 1/2
- 23-2356-2-053 9/16
- 23-2356-2-054 5/8
- 23-2356-2-055 3/4
- 23-2356-2-056 7/8
- 23-2356-2-057 1
- 23-2356-2-058 1 1/8
- 23-2356-2-059 1 1/4
- 23-2356-2-060 1 3/8
- 23-2356-2-999 1 1/2

für S 2 und S 200, S 2000 usw.  
for S 2 and S 200, S 2000 etc.  
para S 2 y S 200, S 2000 etc.



**S 101, 104**

Looper set USA: 03-5250-0-000



14-4004-0-000  
10-4004 USA  
14-4005-0-000  
10-4005 USA  
0,5 mm  
14-4005-0-030  
0,8 mm

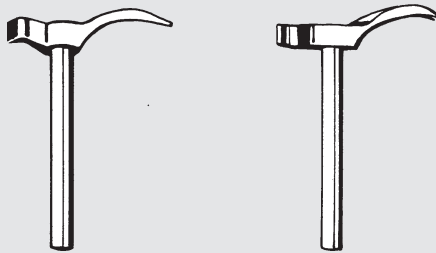

14-4008-1-000  
10-4008 USA  
14-4009-1-000  
10-4009 USA

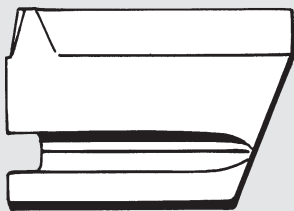

Block/Steel Type A-69-R

- 10-1069-0-001 1/2 - 13
- 10-1069-0-002 5/8 - 16
- 10-1069-0-003 3/4 - 19
- 10-1069-0-004 7/8 - 22
- 10-1069-0-005 1 - 25
- 10-1069-0-006 1 1/8 - 29
- 10-1069-0-007 1 1/4 - 32
- 10-1069-0-008 1 3/8 - 35
- 10-1069-0-009 1 1/2 - 38

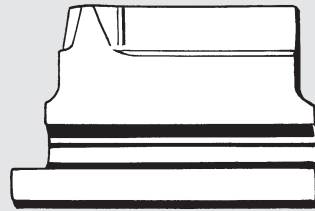

Block/Steel Type A-69-B

- 10-1069-0-073 1/2 - 13
- 10-1069-0-074 5/8 - 16
- 10-1069-0-075 3/4 - 19
- 10-1069-0-076 7/8 - 22
- 10-1069-0-077 1 - 25
- 10-1069-0-079 1 1/4 - 32
- 10-1069-0-080 1 3/8 - 35
- 10-1069-0-081 1 1/2 - 38

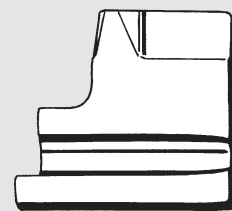

Block/Steel Cord Trim

- 10-1069-0-020 5/8 - 16
- 10-1069-0-021 3/4 - 19
- 10-1069-0-022 7/8 - 22



14-1197-1-000



- 10-3072-0-024 1 1/4 C72-RJRE
- 10-3072-0-059 5/8 CT-RE
- 10-3072-0-060 3/4 CT-RE
- 10-3072-0-067 5/8 CT-LE
- 10-3072-0-023 1 1/4 NE (ohne Auge/without eye)

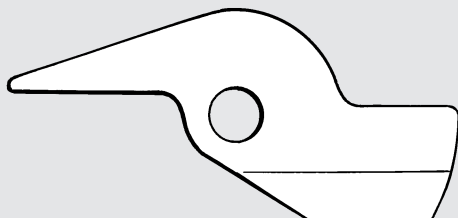

10-2206-1-000

Greifer deutsche Ausführung:

Looper German execution:

Ancoras modelo alemán:

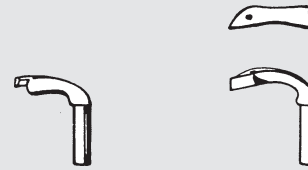

10-4004  
= 14-4004-0-000  
10-4005

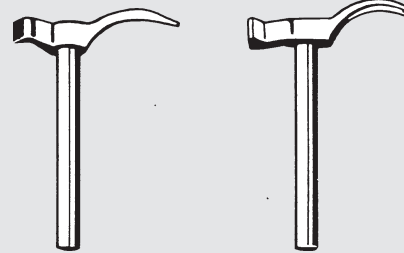

10-4008  
= 14-4008-1-000  
10-4009



10-4006-0-000



10-4007-0-000

10-3072-0-014

Weitere Abmessungen auf Anfrage  
Further dimensions on request  
Otras medidas de ser demandadas

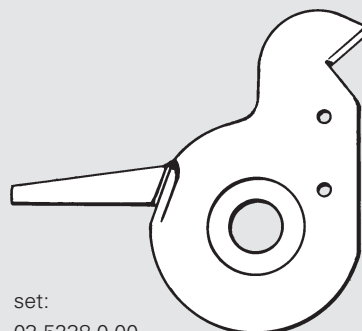
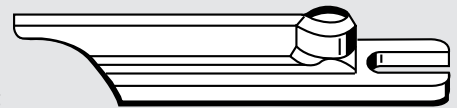

set:  
03-5238-0-00

10-2207-1-000

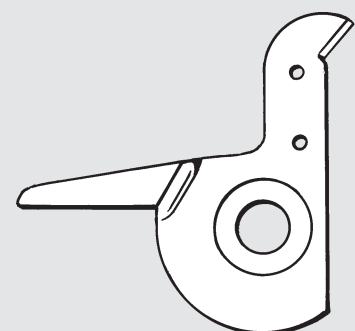

10-2207-1-600



**S 100 (Global BH 770), S 111  
S 211, S 311 XL 21**



17-0069-4-048  
Global:  
522-080-694048



17-0069-4-049  
Global:  
522-080-694049

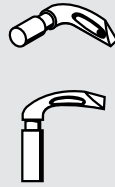

17-0069-4-019

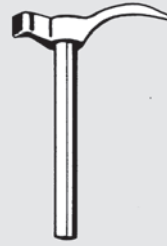

17-0004-9-894  
Global:  
522-980-049894

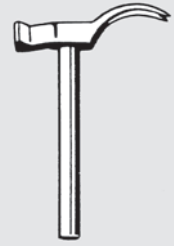

17-0004-9-895  
Global:  
522-980-049895

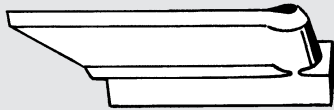

17-0064-5-864 (CA)  
Global:  
522-080-645864

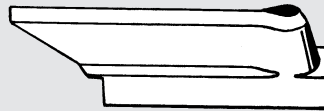

17-0064-5-950 (CB)  
Global:  
522-080-645950



17-0087-0-204

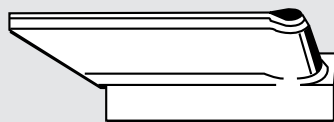

19-0087-0-432

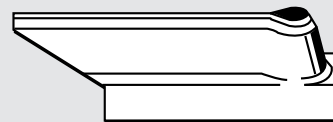

19-0087-0-434

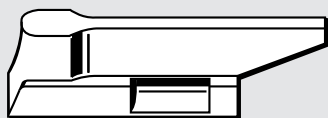

17-0064-5-849 16 mm  
17-0064-5-852 22 mm  
17-0064-5-854 26 mm  
17-0064-5-855 28 mm  
17-0064-5-856 32 mm  
17-0064-5-858 38 mm

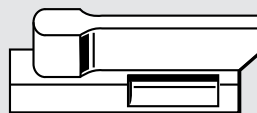

19-0064-5-855

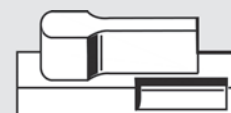

19-0064-5-952



**31, 32, 36, 38, 42, 46, 47, 48**  
**Lockwelt 2000, 3000, 6000, 7000**

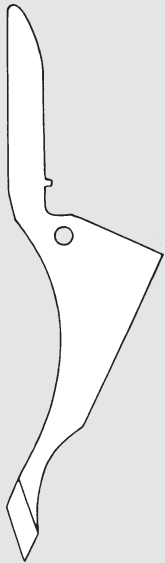

40-0012-2-045 (HSS)  
P 12 XN 1  
Kl. 42

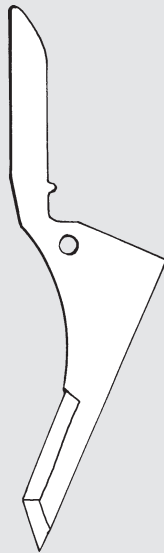

42-0012-0-000 (HSS)  
P 12 XN 1-SP  
Kl. 42



40-0127-2-000  
P 127  
40-0127-0-001 (TIN)

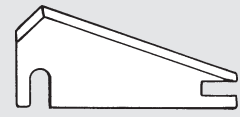

46-1001-4-136  
P 127 Special  
0,6 mm HSS

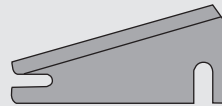

46-1001-5-487  
Ceramic  
Kl. 36, 38, 46, 47

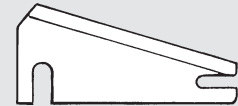

46-1004-9-073  
Kl. 36, 38, 46, 47



32-2019-1-000  
Kl. S32



46-1125-5-000  
Kl. 36, S46, 47

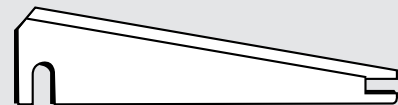

46-1001-5-289



40-0057-6-000



40-0058-5-000



48-1125-5-594 (CT)  
Kl. 38, 46, 47, 48



46-1125-5-581  
Kl. 38



48-1125-5-721  
Kl. 48



67-2462-0-553

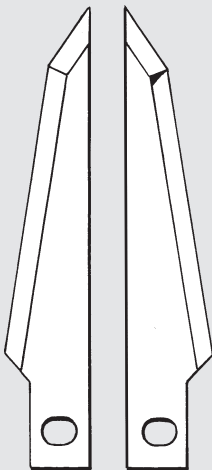

32-2047-1-001 32-2047-1-002  
67-2047-1-001 67-2047-1-002  
32-2047-1-050  
Kl. S 32

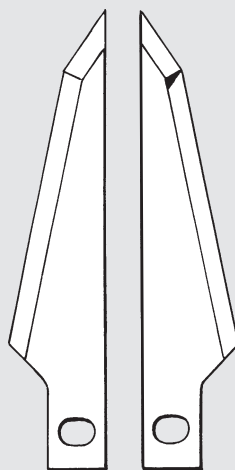

32-2048-1-001 32-2048-1-002  
67-2048-1-001 67-2048-1-002  
32-2048-1-050  
Kl. S 32

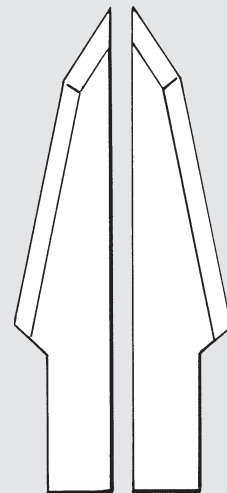

68-0052-0-012

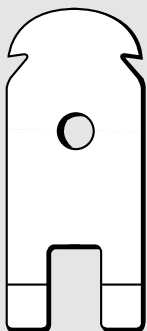

68-0050-0-012



DVN

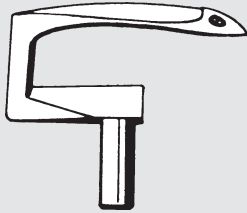

10528

DTN



10083



10204





27, 28, 29, 227, 228, 229, 327, 328, 329, 527, 529  
627, 629, 637, 639, Orion  
Omnitex  
Vega



202142-0-10  
209348-0-10  
270-112



207000-2-00 (CT)  
209347-0-00 (CT)



202143-0-10  
209350-0-10  
270-112/1



203066-0-10  
297-112



207006-2-00 (CT)



202145-0-10  
270-113

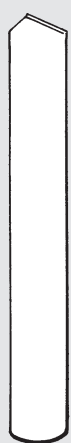

207011-0-00



202146-0-11  
270-113/1



207015-2-00 (CT)



207024-2-00 (CT)



207017-2-00 (CT)



209593-0-00



203010-0-10  
209358-0-10  
277-112



207002-2-00 (CT)  
209357-2-00 (CT)



920780-0-10



**27, 28, 29, 227, 228, 229, 327, 328, 329, 527, 529  
627, 629, 637, 639, Orion  
Omnitex  
Vega**



202932-0-10  
209356-0-10  
279-B-112

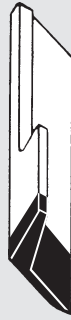

207001-2-00 (CT)  
209355-2-00 (CT)



203012-0-10  
277-113  
27.77-113

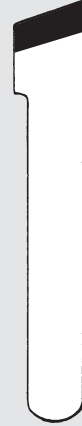

207016-2-00 (CT)

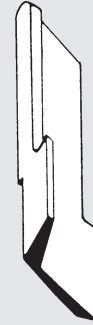

203783-0-10  
209352-0-10  
27.77-1121

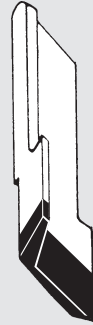

207003-2-00 (CT)  
209351-2-00 (CT)



203759-0-10  
209354-0-10  
27.77-112

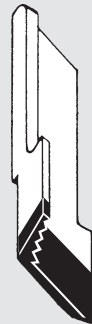

207004-2-00 (CT)  
209353-2-00 (CT)

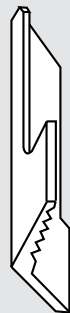

209341-0-10



209342-2-10 (CT)



209340-2-10 (CT)



209425-2-01 (CT)



204693-0-11  
290-113 SP (1 mm)



207020-2-01 (CT)



207651-0-00  
(1,5 mm)



204693-0-11 BAK  
Ceramic



209426-2-00 (CT)



205151-0-00



27, 28, 29, 227, 228, 229, 327, 328, 329, 527, 529  
627, 629, 637, 639, Orion  
Omnitex  
Vega



207025-2-00 (CT)



209344-2-00 (CT)



211424-2-00 (CT)



208011-0-01



206208-0-00  
kleines Öhr  
small eye  
Agujero pequeño



206209-0-00  
großes Öhr  
large eye  
Agujero grande



204021-0-10  
27.277-074  
großes Öhr  
large eye  
Agujero grande



204033-0-10  
27.277-075  
kleines Öhr  
small eye  
Agujero pequeño



204022-0-10

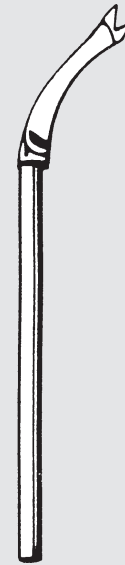

202092-0-11  
270-D-074-1

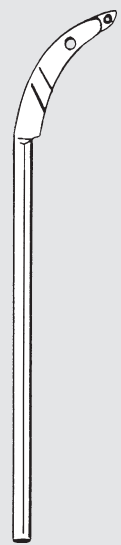

206512-0-02

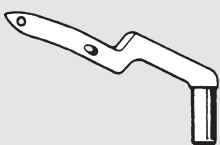

209213-0-00  
großes Öhr  
large eye  
Agujero grande

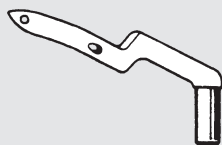

209223-0-00  
großes Öhr  
large eye  
Agujero grande

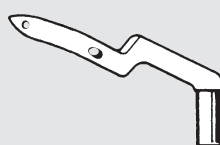

209248-0-00  
kleines Öhr  
small eye  
Agujero pequeño

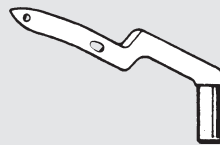

209249-0-00  
kleines Öhr  
small eye  
Agujero pequeño

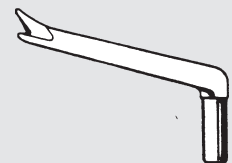

209247-0-00



27, 28, 29, 227, 228, 229, 327, 328, 329, 527, 529  
627, 629, 637, 639, Orion  
Omnitex, Vega

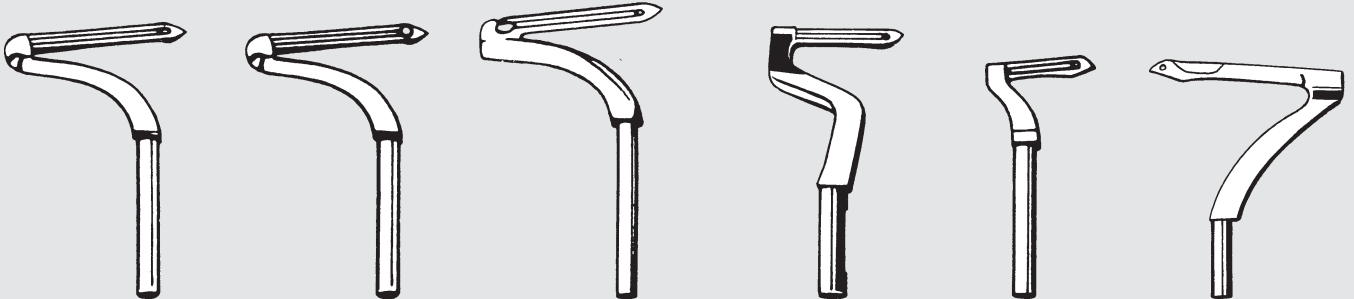

202094-0-13  
270-075  
kleines Öhr  
small eye  
Agujero pequeño

202095-0-13  
270-075/2  
großes Öhr  
large eye  
Agujero grande

202413-0-13  
270-075/1

207722-0-01

204676-0-11  
290-075/2

206048-0-13

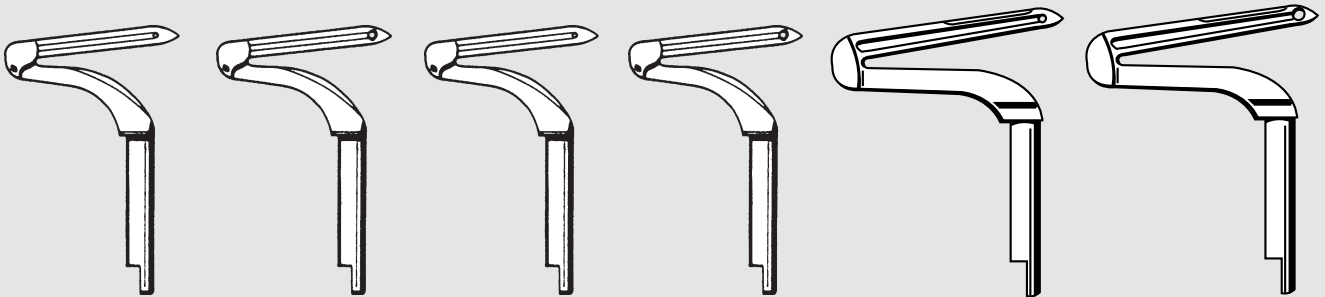

209264-0-00  
kleines Öhr  
small eye  
Agujero pequeño

209265-0-00  
großes Öhr  
large eye  
Agujero grande

209266-0-00

209267-0-00

211266-0-00  
kleines Öhr  
small eye  
Agujero pequeño

211267-0-00  
großes Öhr  
large eye  
Agujero grande

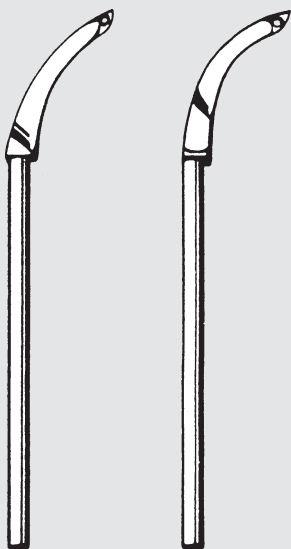

203005-0-10  
277-074

203755-0-10  
207208-0-00  
2777-074



209261-0-00

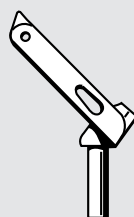

211248-0-00  
kleines Öhr  
small eye  
Agujero pequeño



211249-0-00  
großes Öhr  
large eye  
Agujero grande



207995-0-00

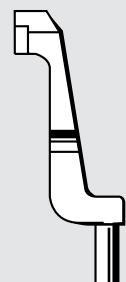

207996-0-00



27, 28, 29, 227, 228, 229, 327, 328, 329, 527, 529  
627, 629, 637, 639, Orion  
Omnitex

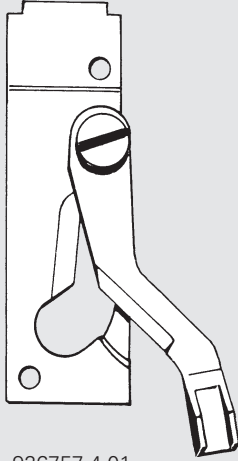

926757-4-01

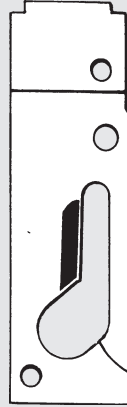

926753-2-01 (CT)



926756-2-01 (CT)



926758-0-01



923918-0-01



923919-0-01



926752-4-00

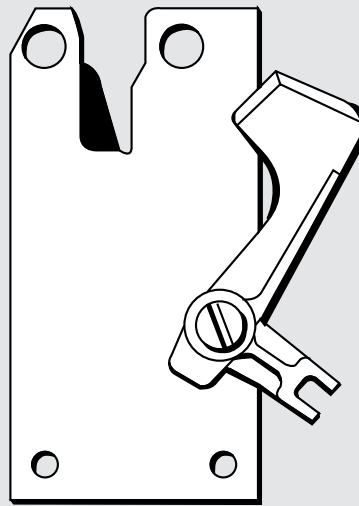

928533-4-01

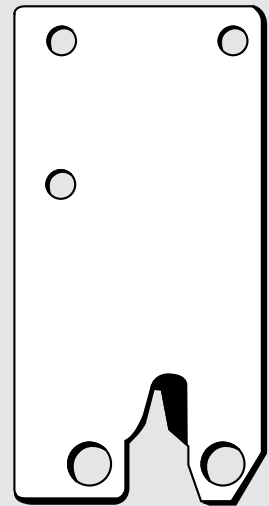

928531-2-00 (CT)

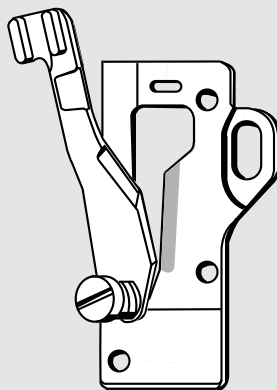

925891-4-00

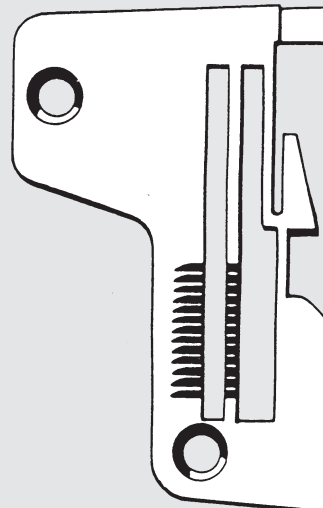

202148-0-10  
270-114



202507-0-10



27, 28, 29, 227, 228, 229, 327, 328, 329, 527, 529  
627, 629, 637, 639, Orion  
Omnitex

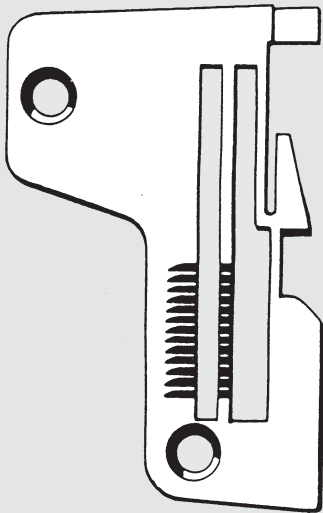

202504-0-10  
270-1141

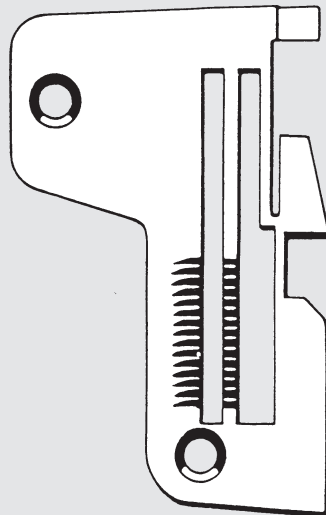

202508-0-10

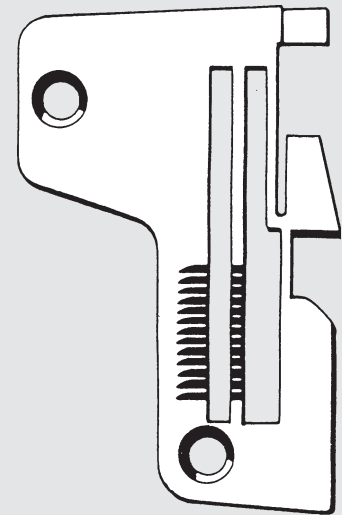

202590-0-10

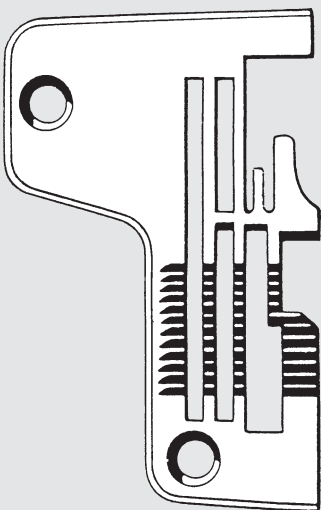

204026-0-10  
27-277-114

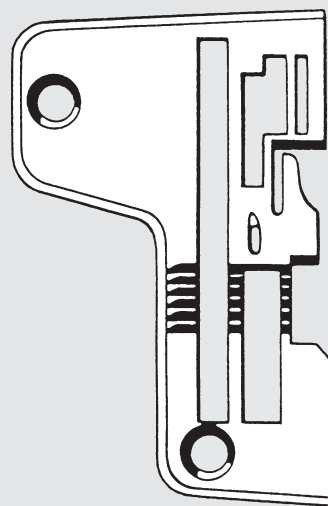

204695-0-11  
290-114/1

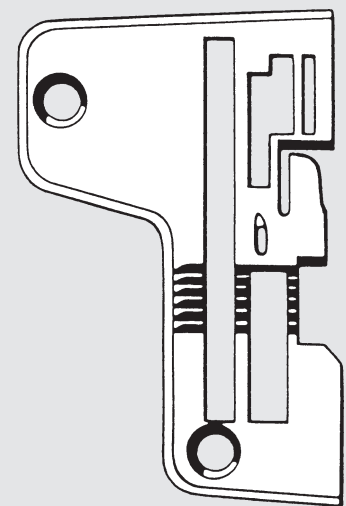

204809-0-00



21 und 24 Stella  
25 und 26 Stella



200271-0-10  
1112  
CT 200271-0-10



200274-0-10  
1113  
CT 200274-0-10



200403-0-10  
2112



CT 200404-0-10

427, 429

siehe/see/véase  
Siruba

63, 64, 65, 155, 261, 262, 263, 264 Sirio  
73  
91, 93, 94 MIZAR

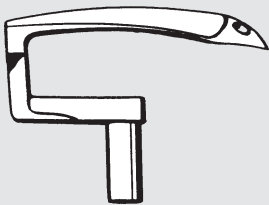

302057-0-13  
633-075/2

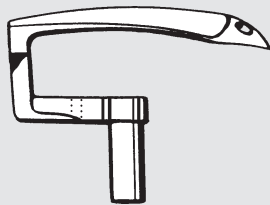

312057-0-00

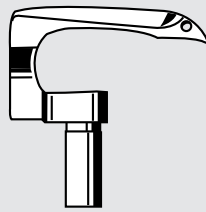

303419-0-12

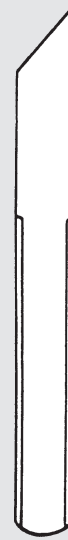

302808-0-10  
63.78-113

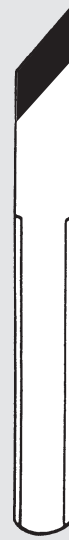

305670-2-00 (CT)



315507-0-00

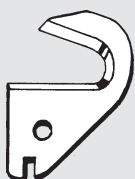

303012-0-10



302807-0-10  
63.78-112



305671-2-00 (CT)



315506-0-00

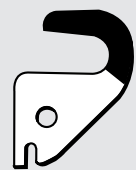

315506-2-00 (CT)



63, 64, 65, 155, 261, 262, 263, 264 Sirio  
73  
91, 93, 94 MIZAR



318735-0-00

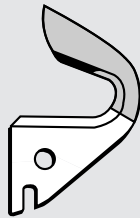

318792-2-00 (CT)



318791-2-00 (CT)

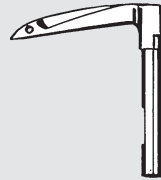

304186-0-13  
Kl. 264-22-4ML-01

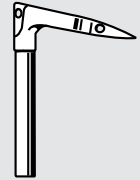

101572-0-12



318794-2-00 (CT)

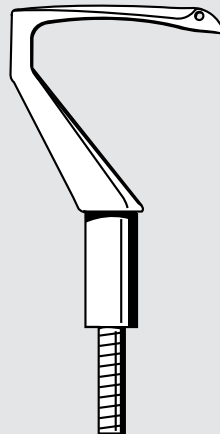

315863-2-02

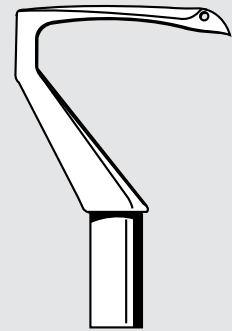

321128-0-10  
F 63-45-3 MD-05

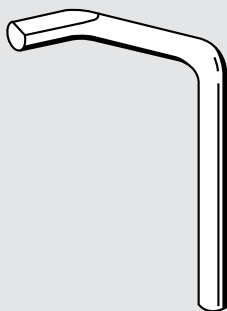

315805-0-00

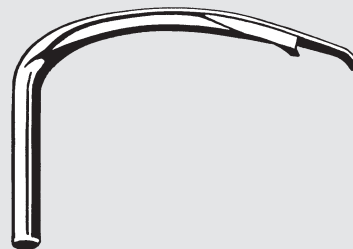

319093-0-00

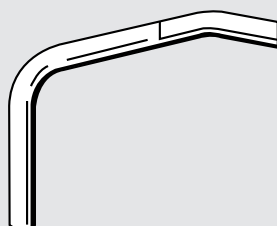

308142-0-00

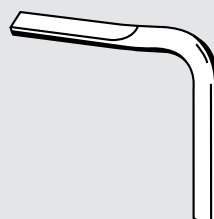

321164-0-00





63, 64, 65, 155, 261, 262, 263, 264 Sirio  
73  
91, 93, 94 MIZAR

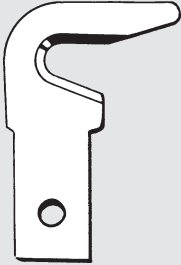

306223-0-10

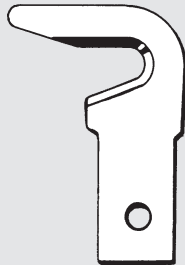

306224-0-10



306234-0-00



306235-0-00

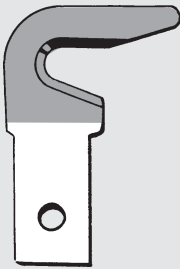

306286-2-00 (CT)

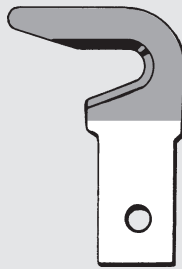

306285-2-00 (CT)



306284-2-00 (CT)



306283-2-00 (CT)

171, 177



924670-0-20



924638-0-10



944422-0-00

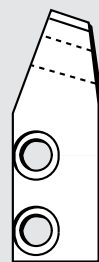

933185-0-00



933201-0-00



933186-0-00



**183 - 00 - 4 MR 04 - 6,0 mm**



350453-0-00



350452-0-00

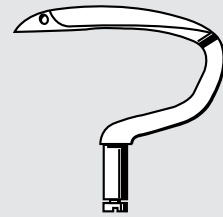

350145-2-11

**183 - 00 - 4 MR 01 - 5,6 mm**



350069-0-00



350183-0-00

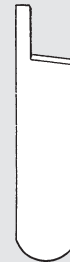

350107-0-00

**184**

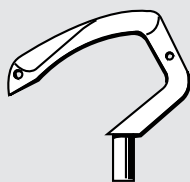

351161-0-10

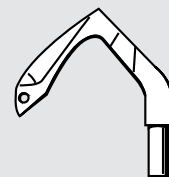

351163-0-10



14 U

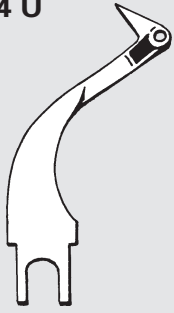

410262

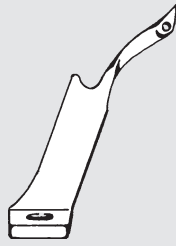

410434

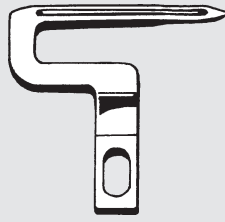

410452

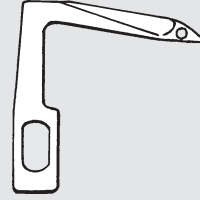

412553

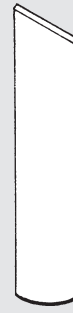

410295



412585

47 W, 51 W, 52 W, 52 K  
104 W, 110 W, 136 W, 236 G, 236 U, 236 W

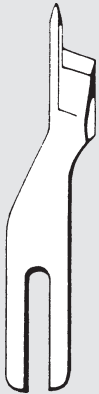

241574 (HSS)

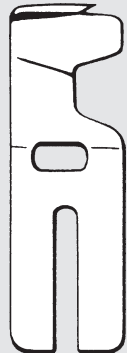

238548

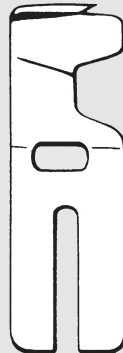

233934

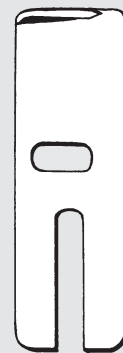

238508

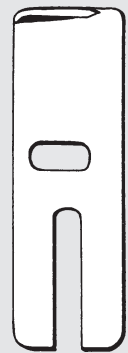

238508 (HSS)

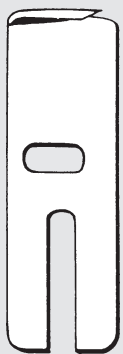

238543

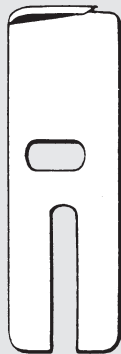

238546



8061 A-3,1

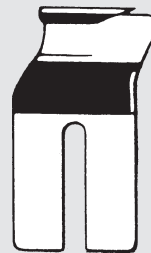

249191-3,1



249191 (HSS)

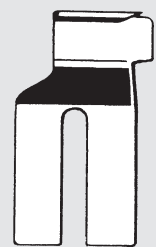

263735

261-U

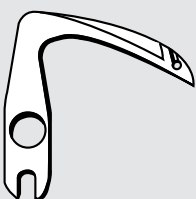

32820

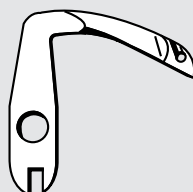

32821

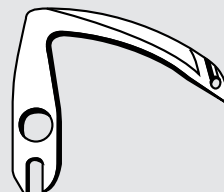

32823

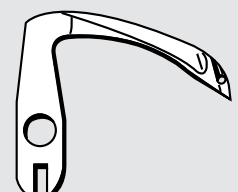

32824



71-1, 3, 5, 6, 11, 12, 13, 30, 31, 32, 34, 35, 40, 42, 45, 101, 107  
271-K 11, -K 13  
371, 471, 1371 A

HSS = High speed steel  
Acero rápido de  
alto rendimiento

23443 - 23459:

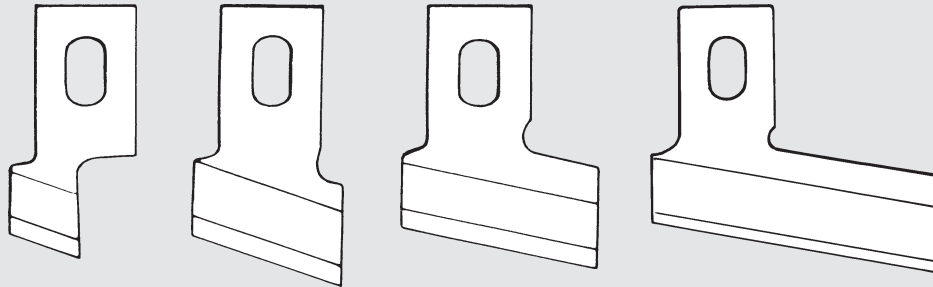

71 1/8	71 13/16
71 1/4	71 7/8
71 5/16	71 15/16
71 3/8	71 1
71 7/16	71 1 1/16
71 1/2	71 1 1/8
71 9/16	71 1 3/16
71 5/8	71 1 1/4
71 11/16	71 1 3/8
71 3/4	71 1 1/2

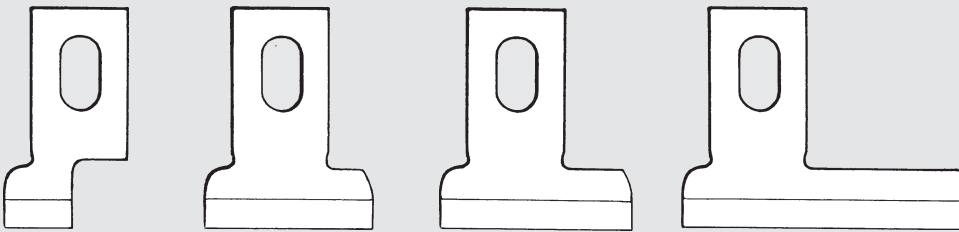

71-90 1/8	71-90 11/16
71-90 1/4	71-90 3/4
71-90 5/16	71-90 13/16
71-90 3/8	71-90 7/8
71-90 7/16	71-90 15/16
71-90 1/2	71-90 1
71-90 9/16	71-90 1 1/8
71-90 5/8	71-90 1 1/4

81



42305  
CT 42305



42309  
CT 42309

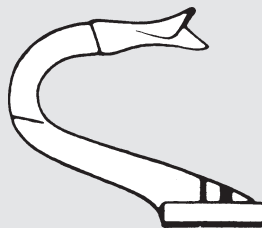

42072

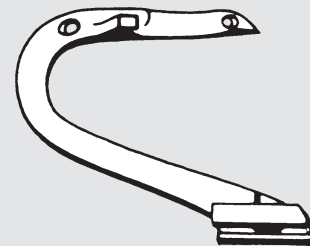

42220

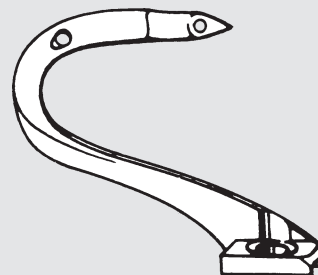

42239

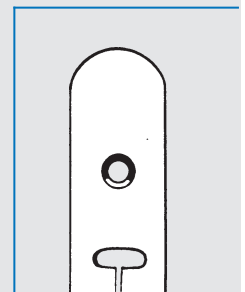

71, 271 K



40048  
Kl. 71-30



39609  
Kl. 71-30



39867  
Kl. 71-48/71-112

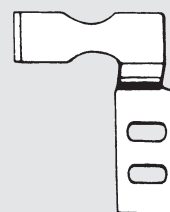

40035  
271926

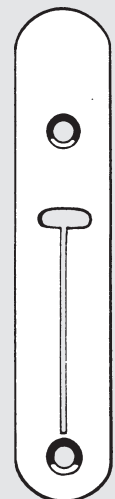

39608  
Kl. 71-30



96, 451 K 11  
245, 251



147211  
276489 (CT)



5730, 142032, 52131  
5730 3/32

175, 375  
Consew 260, 261



175085

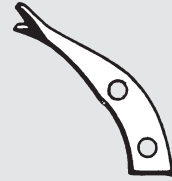

175547

246 K, 460, 990



164308



CT 164308



164550

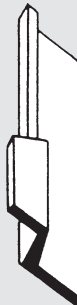

164026



CT 164026



164556



CT 164556



82264



CT 82264



107797



164037



164233

164552

164728

CT = 164813

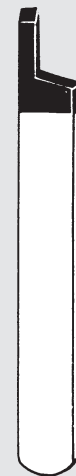

164809 (CT)



164813 (CT)



246 K, 460, 990



164045



164252



164375



164619

68, 69, 269 W, 270

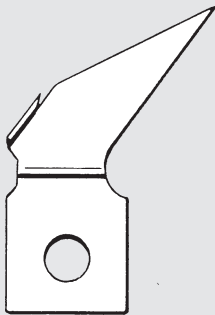

55459



55458



239372



239367

281



785780-001



299 U

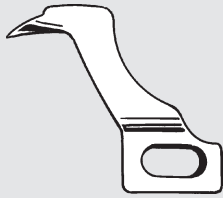

548231

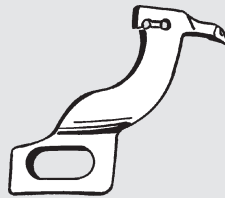

548232

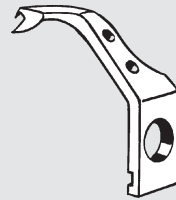

548207

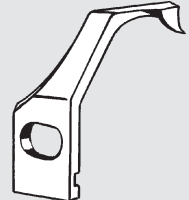

548205

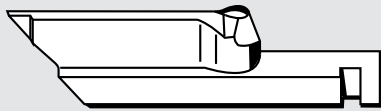

544599

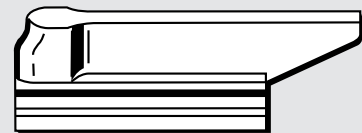

548762 1/2"

548763 5/8"

548764 3/4"

548765 7/8"

548766 1"

548767 1 1/8"

548768 1 1/4"

548769 1 3/8"

548770 1 1/2"

548771 1 5/8"

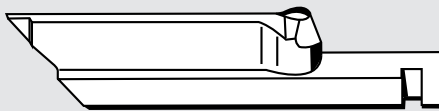

548886

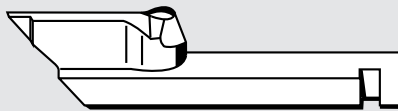

548935

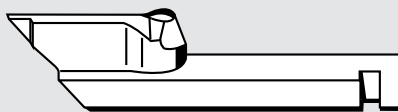

548936

300 U, 300 W, 302 U, 320 W

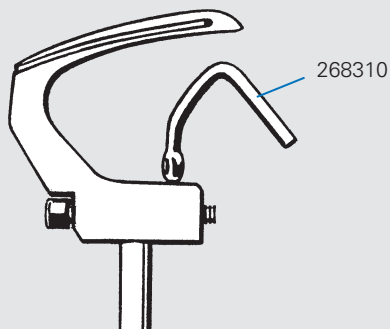

268382  
281208

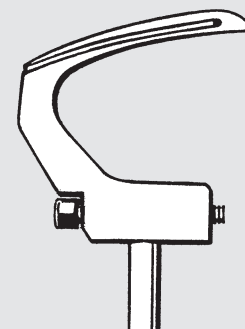

268380



369

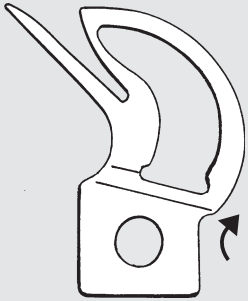

239715

375 B

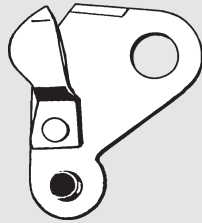

373537



373539

400 W 11



CT 270619

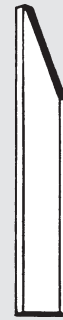

270616



270619

491 D, 591 D, 591 E, 601 D

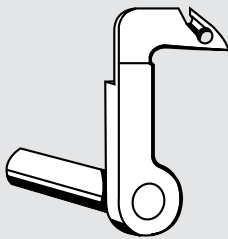

414030

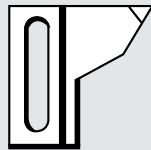

414029



540741

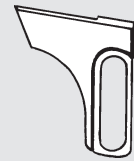

540760

660 AX 2

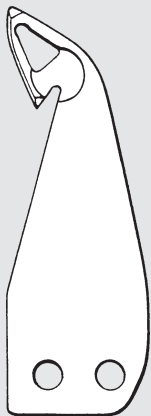

GU 3605  
Peschke Nr. 19



GU 3606  
Peschke Nr. 18

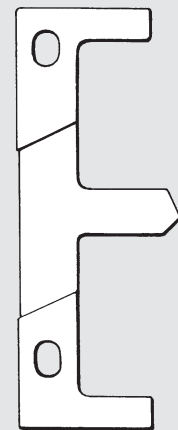

107519





**1831 U, 1832 U, 1842 U  
(= Kingtex SH 6000)**



377462 (CT)  
6031314 C 500



344559 (CT)



377465 (CT)



377559 (CT)  
G 6050113 C 500 (CT)

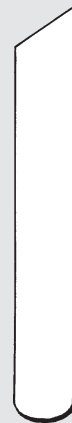

377443  
6031218 P 700



377560  
G 6050114 P 700

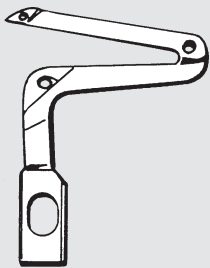

377602  
LL 603884

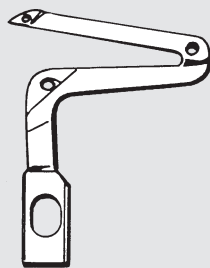

377640  
LL 604885

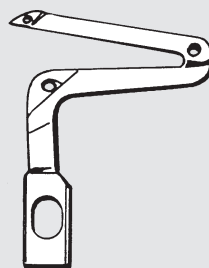

377641  
LL 604884  
LL 600884

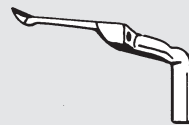

377600 (A)  
UL 603880  
UL 600880

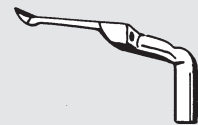

377601 (C)  
UL 603886  
UL 600886

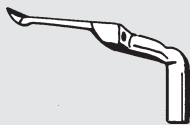

377740 (B)  
UL 603881  
UL 600881

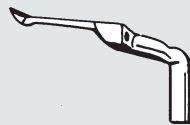

377638 (D)  
UL 604883  
UL 600883

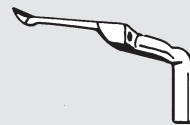

377639 (F)  
GUL 604152

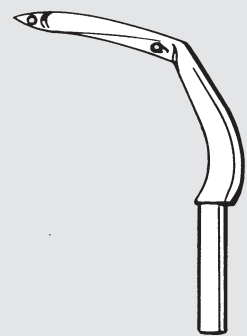

UL 605294

**695 = Union KI. 39500  
698 = Union KI. 39800**

**801 U = Brother KI. B 561  
802 U = Brother KI. B 571  
812 U = Brother KI. B 581  
831 U = Brother KI. B 511**

**832 U = Brother KI. B 531  
842 U = Brother KI. B 551  
881 = Brother  
882 = Brother  
892 = Brother**



727, 737, 747, 757  
700 H, 700 F, 700 FS  
700 FX



KR 35



KR 55



KR 23 (CT)



KR-23 A (CT)



K-23 C (CT)



KR-35 C

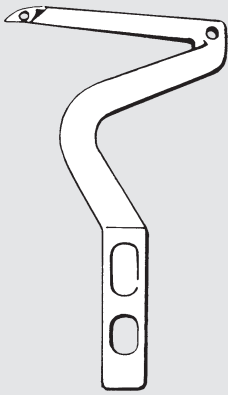

KL 25

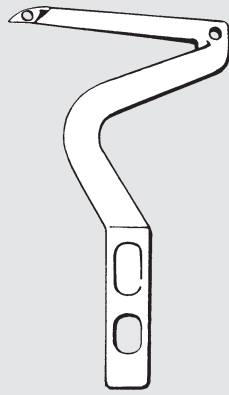

KL 25 A

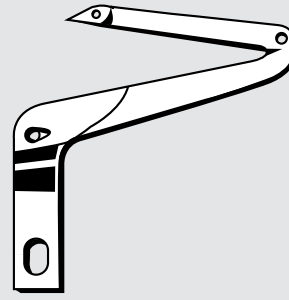

KL 65

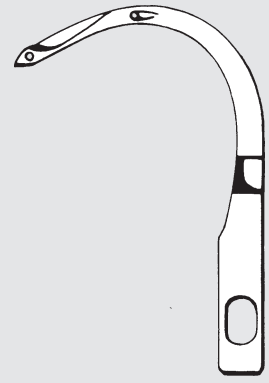

KM 04



LP 22



LP 24



LP 26



LP 21

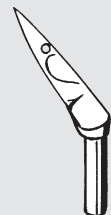

LP 36 A



**C 007**



CRL 09 J

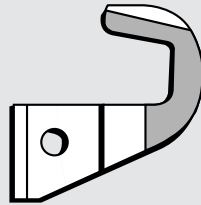

CRL 103

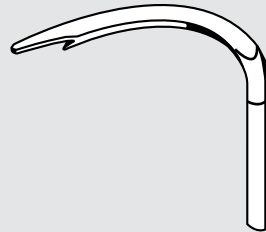

MH 41



MT 01

**F 007**

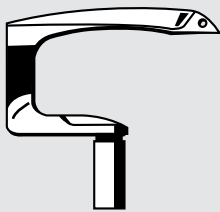

FS 03

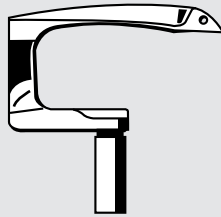

FS 04

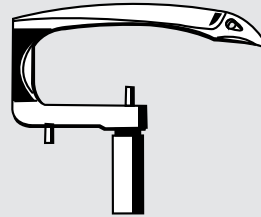

ME 28

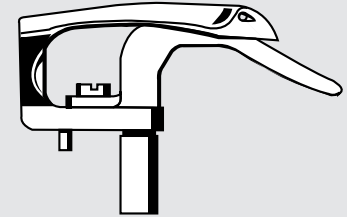

ME 28 P

**HF 008**

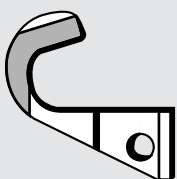

FR 34



FR 40

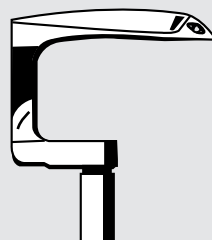

HE 21 Q

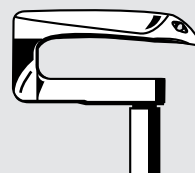

HE 22 Q

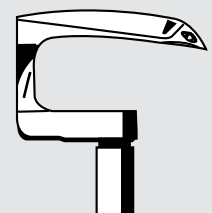

HE 22 R

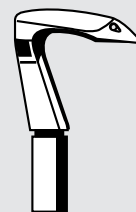

HE 21

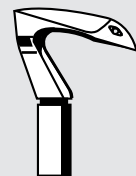

HE 22



**SC 88**

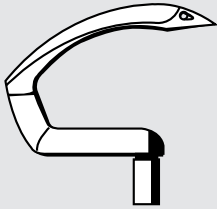

CB 28

**VC 008**

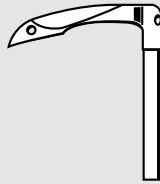

VE 51

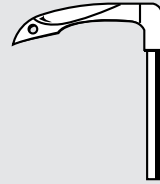

VE 51 P

**Z 008**

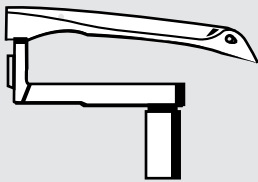

ZD 21

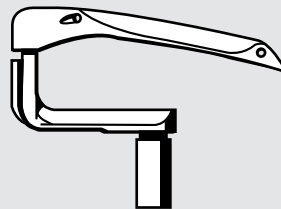

ZD 22



VLA 48-4  
(18702 Adamson)



1870053



1840096

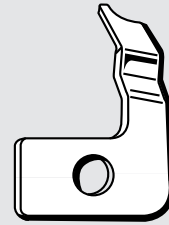

1840097

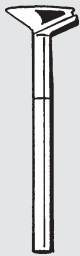

1870047  
KI. 141-23  
-28  
410  
415



1870004  
KI. 141-21  
-24  
-27  
-30  
-40  
-50



**6300, 6600**



1250004-229 B



1250004-237 B



1650004-229 (CT)



1270004-229 (CT)

**AD 158**

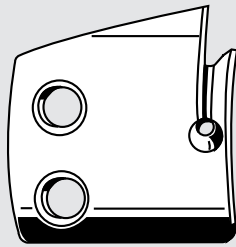

2111407-553-B

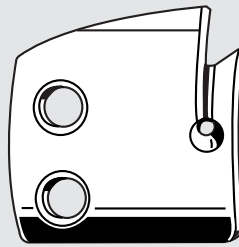

2111417-553-A



2111417-556-B



## 2100, 2200



2149 (AB)



2170 (AA)

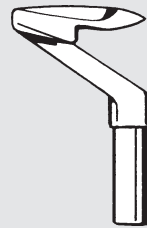

2108 A

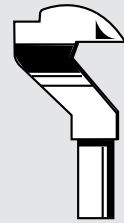

2108 B

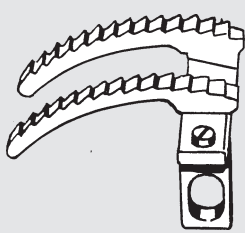

2105

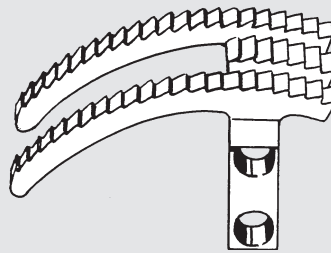

2126



2111

## 2000 3000



2008 K (UX)



2008 Q (UXA)  
3008 Q

## 33700

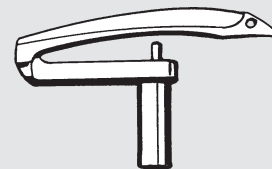

33709 C

## 35600, 35700, 35800

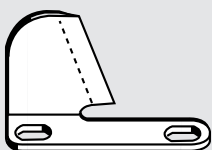

35796 B

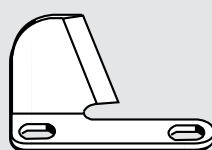

35796 C

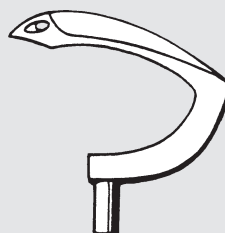

AV = 35809 AY



AU = 35808 AY



AY = 35809 BY



**34700, 34800  
92800, 93800, 94800**

**Serie CS + FS Seite 109  
page 109  
pagina 109**



34749

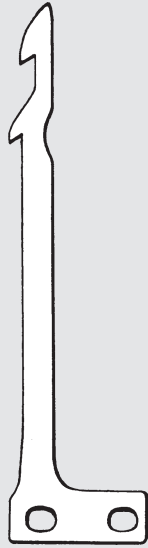

34749 K  
34749 M

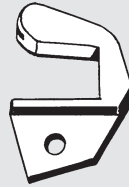

34770



34770 K



34709 (UR)



34709 D (URD)

**36200 Flatseamer**

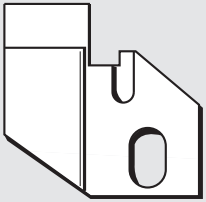

999-302 N 1033



36250 SUPER  
A 10469



G 36250  
= CT 36250



36270 SUPER  
36270 B  
A 10470



CT 36270

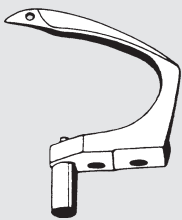

36208 A

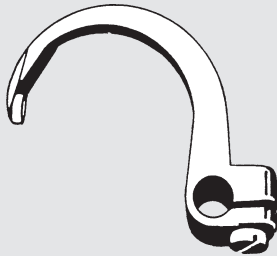

36251 F



36251 FD



36251 E (A)



36251 W

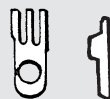

36240 (D)



G 36240 (VD)



36240 J





## 39500



G 39570  
39570



CT G 39570



39570 SC  
Solid carbide  
Metal sólido duro



G 39570 A  
(A 9181)

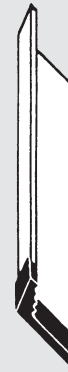

A 9392 (CT)



G 39570 JU  
(A 9259)



39570 J

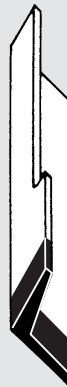

CT 39570 J



39570 K

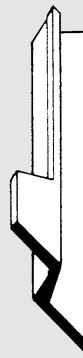

39570 L



CT 39570 L

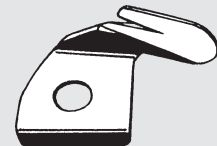

39556 K



39556 L



39549



39549 BAK  
Ceramic



G 39549 N (CT)



39549 SC  
Solid carbide  
Metal sólido duro

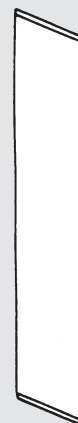

G 39549 JU  
(A 9071)



G 39549 SU (CT)

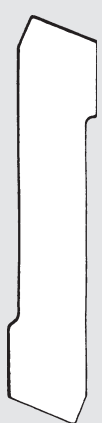

39549 J



**39500**



39549 J BAK  
Ceramic



CT 39549 J

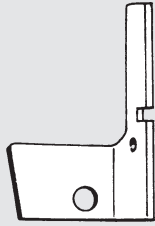

99669 K (GM)

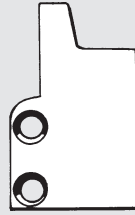

99670 L



99669 (GC)

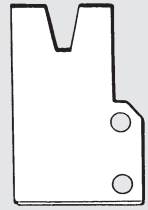

99670 (GD)



39508 B

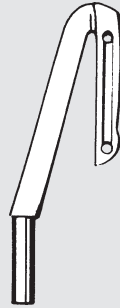

39508 D

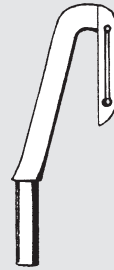

39508 P



39560 B

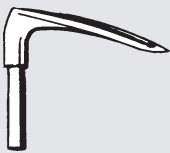

39508 A (CC)  
G 39508 A (UM)

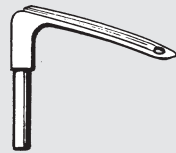

39508 E (CK)



G 39508 AV (GC)  
(A 9050)

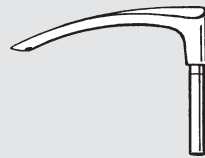

39508 C

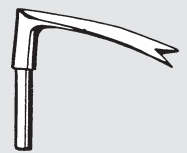

39560 A (E)

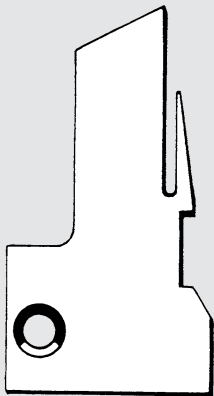

39524 AB 1/8  
(AX 1/8)  
ohne Transporeurschlitz

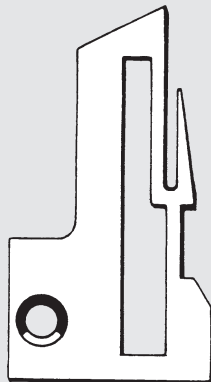

39524 AB 1/8  
(AX 1/8)

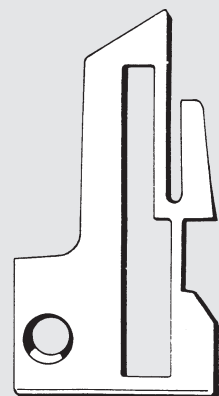

39524 AB 5/32  
(AX 5/32)



39500

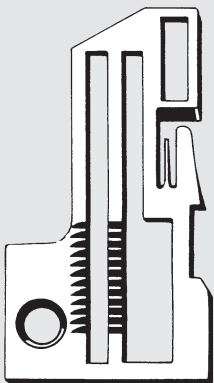

G 39524 AV (GB)

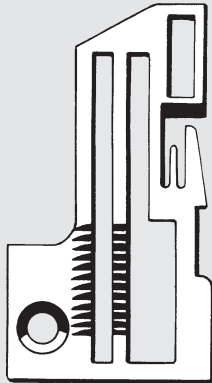

G 39524 AW (GC)  
GB 39524 AW (HN)

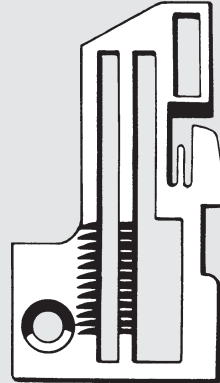

GA 39524 AW (HH) 5/32

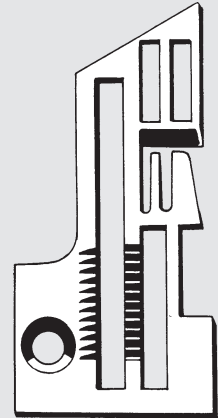

39524 W (AN)

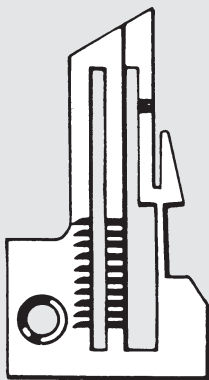

39524 B 3/32  
(V 3/32)

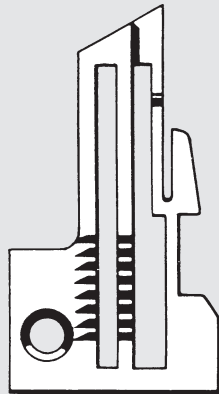

39524 B 1/8  
(V 1/8)

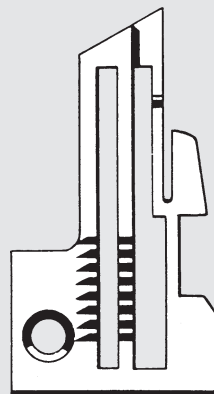

39524 B 5/32  
(BH)

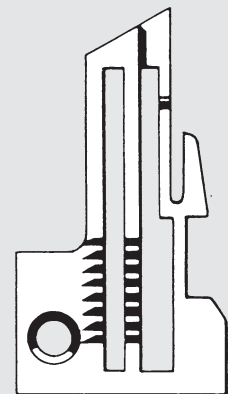

39524 P  
(AJ)

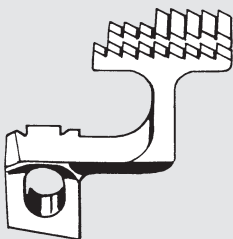

39526 AW

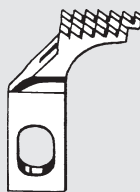

39505 B

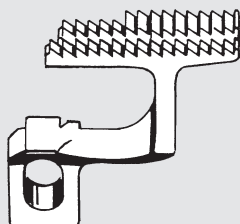

39526 B

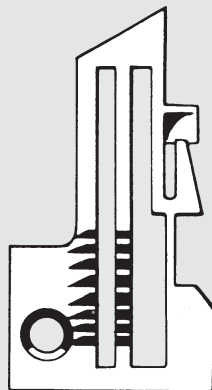

39524 C 1/8  
(AC 1/8)

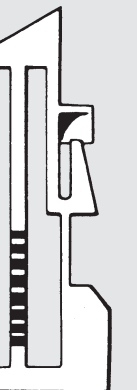

39524 C 5/32  
(AC 5/32)

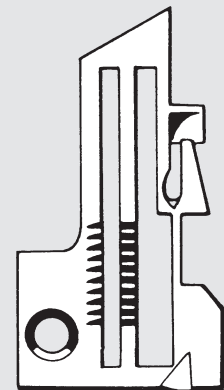

A 9953 1/8  
(HV 1/8)



**39500**

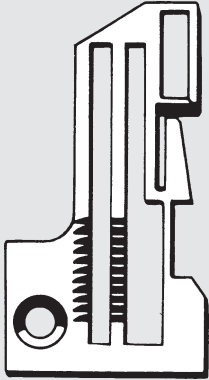

GA 39524 C 1/8 (HB)

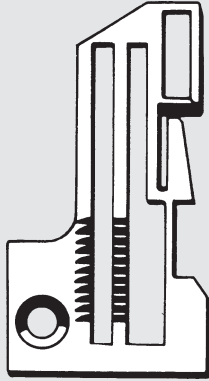

GA 39524 C 5/32 (HC)

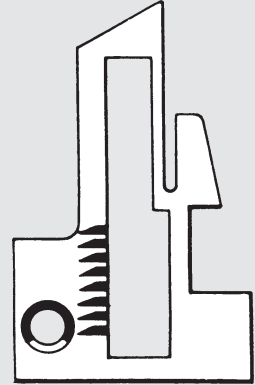

39524 J

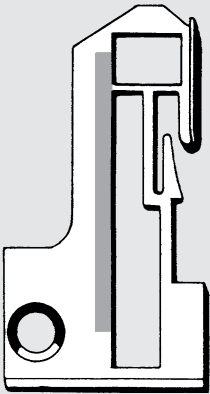

GA 39524 JU (HE)

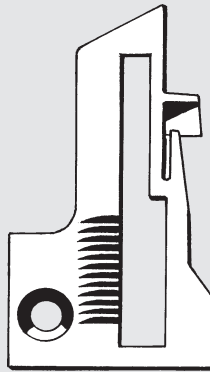

39524 AS (BE)

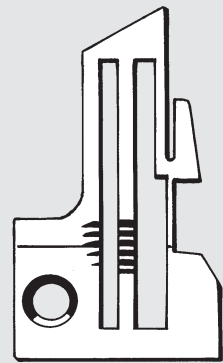

39524 D (AM)

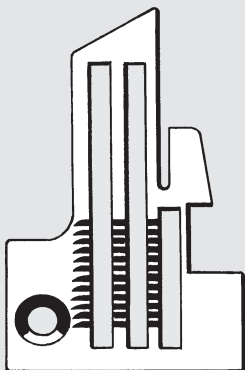

39524 N (AH)

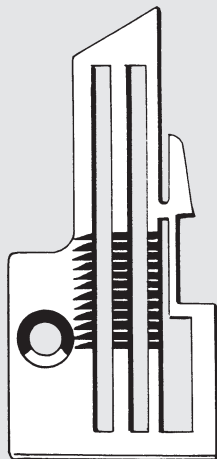

39524 BF 1/8 (BK)

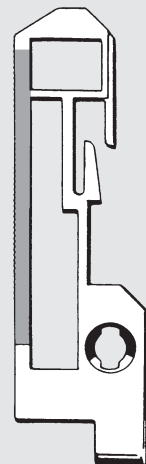

A 9608 B (HG)



## 39800

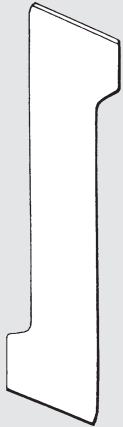

39849

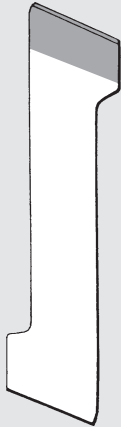

CT 39849

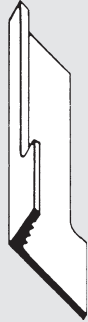

39870

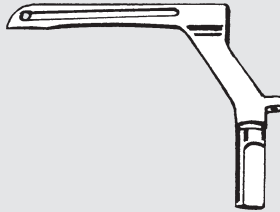

39808 CY

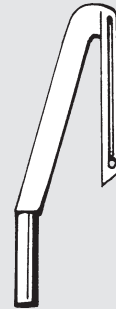

39808 D (ACZ)

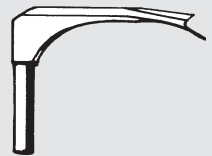

39860 H

## SP 151, SP 161, SP 172 = Juki

Seite 36-39  
page 36-39  
pagina 36-39

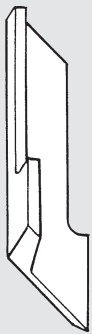

118-45906

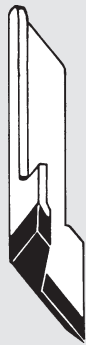

CT 118-45807



122-20307

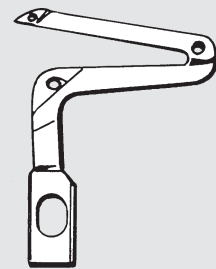

122-40107

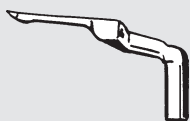

122-47508

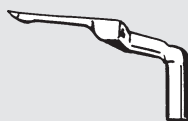

122-47300

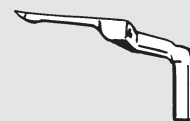

122-47102



**39200**

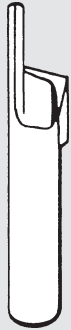

39270 A



39270 D



39270 E  
Kl. 39200 / 39600

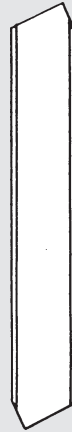

39249 A



39249



39249 K

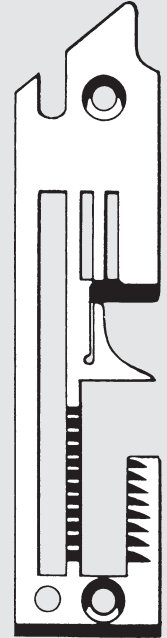

39224 AC 3/32  
39224 AC 1/8  
39224 J  
39224 AA

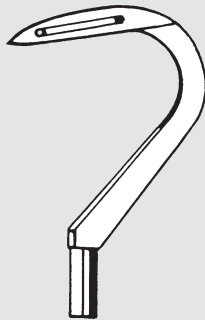

39208 B

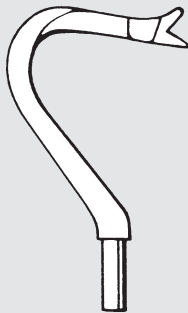

39160

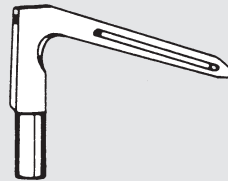

39208 AA

**FS 122, 123, 132, 133, 311, 312, 322, 323, 332**  
**CS 122, 132**  
**92800, 93800, 94800**  
**MFC 7000 Series**  
**MF 7000 Series**

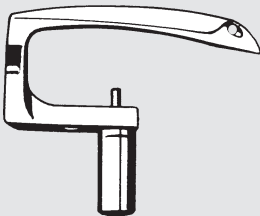

52708 B

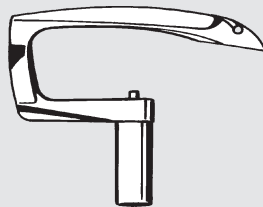

50309 K



34770 K



34770 EL



34709 D (URD)

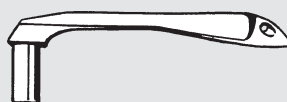

34709 (UR)

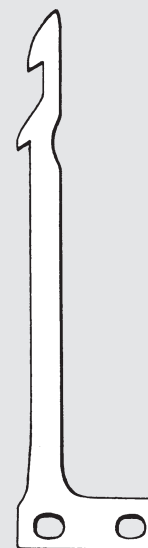

34749 K  
34749 M



34749 EL



## 41300

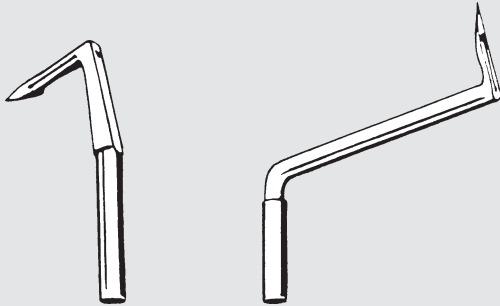

41308 B

41308 BX = 41309 A

## 51200

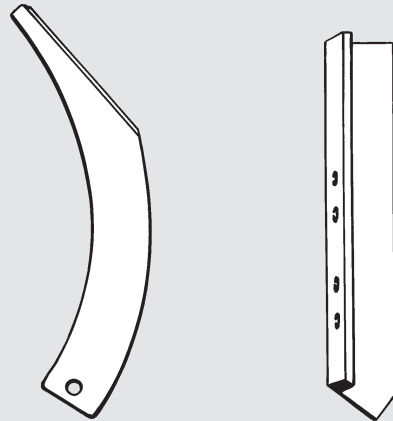

51249 B

51270 S

## 51700, 56700

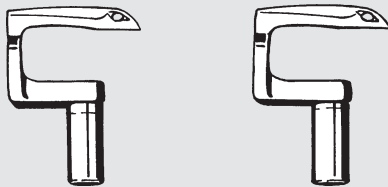

51708

51709

## 52700

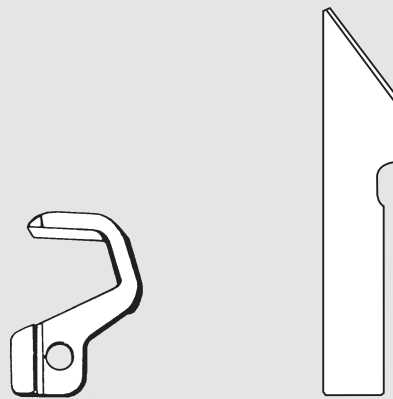

52770 C (B)  
52770 D (E)

52749 A

## 57700

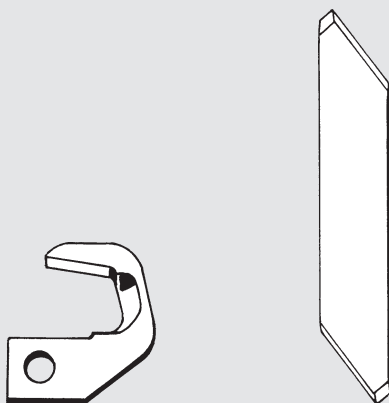

57770 A (D)

57949



**52700 BKZ Galkin**

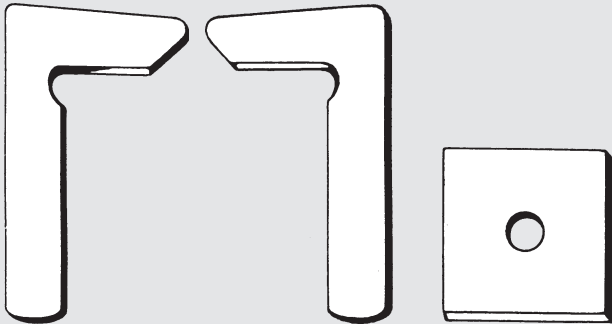

167 L  
CT 167 L

168 R  
CT 168 R

169

**57700 BKZ Galkin**

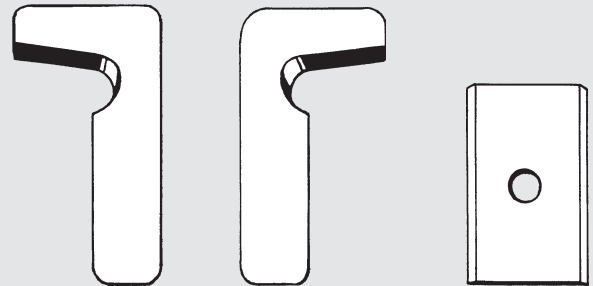

11110  
CT 11110

11111  
CT 11111

11109  
CT 11109

**53100**

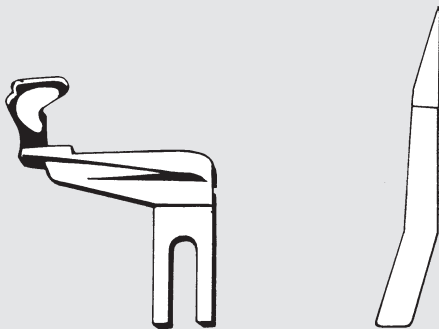

G 53170 R

9949 AR

**53300, 53400**

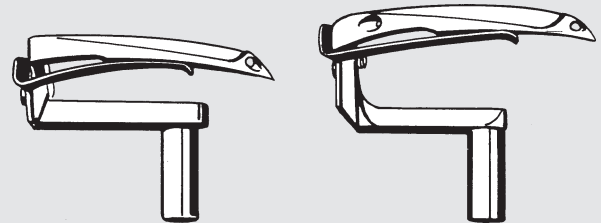

53407

53409

**54200, 54400**

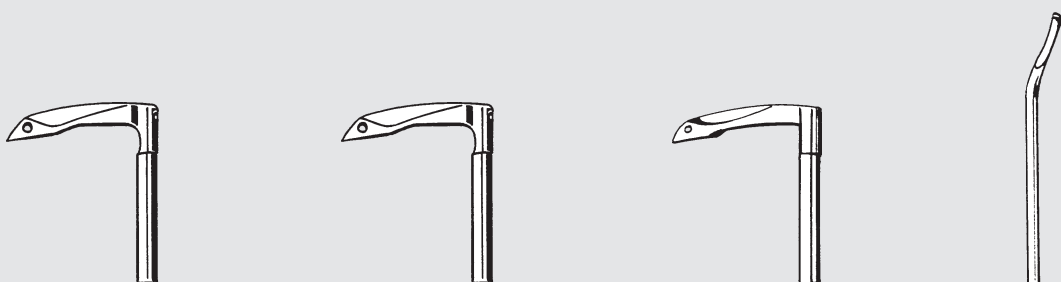

54208 B

54208 (BZ)

54208 A (CB)

54211 A





52700, 52800, 52900  
57700, 57800

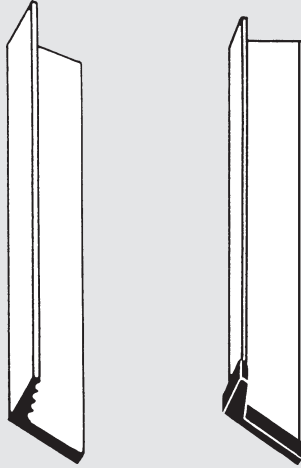

52970 E

A 9464 (CT)  
= 52970 D (CT)

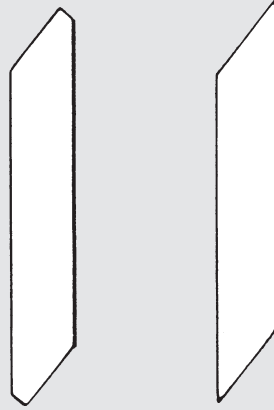

52949 A

52949

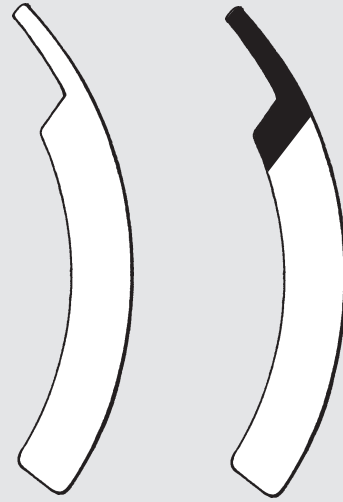

52970 C

CT 52970 C

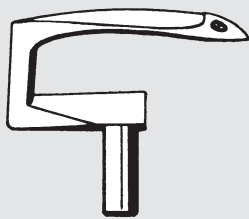

52808 E

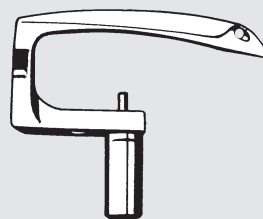

52708 B



52845 A (B)  
= 52945 M (F)

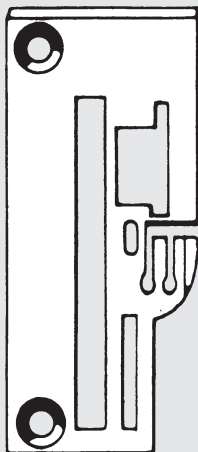

G 52928 A 5-8

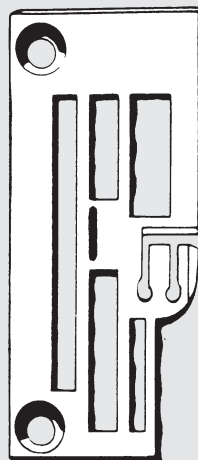

52928 A 16-8

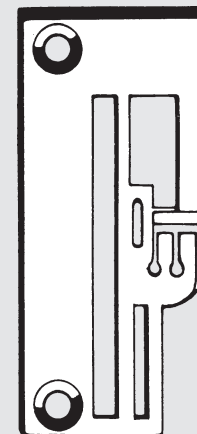

52924 BH 5-8



**51400, 51408, 51900, 52300, 52900  
XF 500, LF 611  
53700, 53800, 56900**

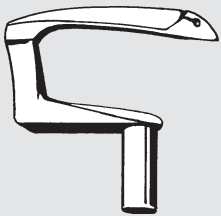

G 51409 C

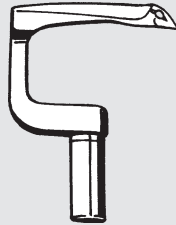

51409

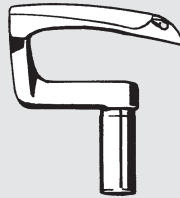

51408-12

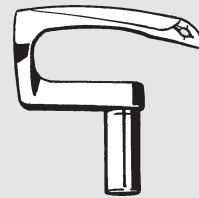

51408-16

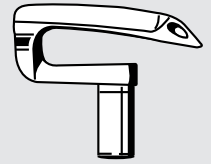

51508 M-18

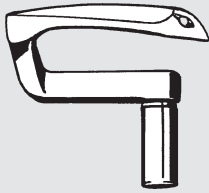

51908 B-8

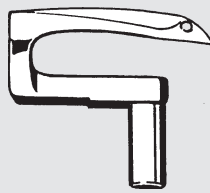

51908 B-9

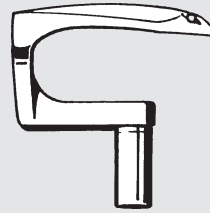

51909 C

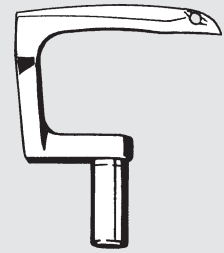

51909 D-9



51470



51449



CT 51449



52949 B

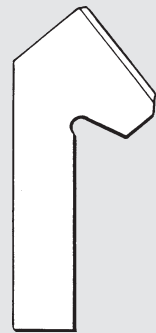

A 9540



## 15400



15470

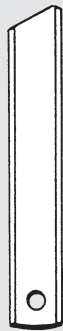

15449



15408 A



15408 G



15460

## 75400



75449



75470 LA



75449 LA



75449 LB  
75449 LA

## Lewis



36-16  
KI. 150



36-19  
KI. 156-20



36-21  
KI. 200



81200, 80200, 80600, 80700  
80800, 81300 A, 81500

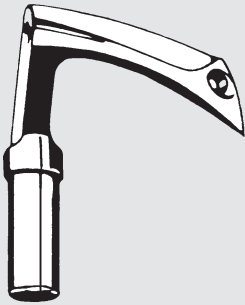

AS 26 XA

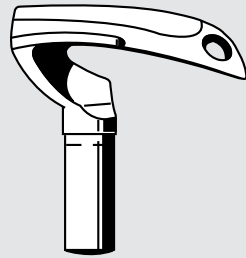

A 8375

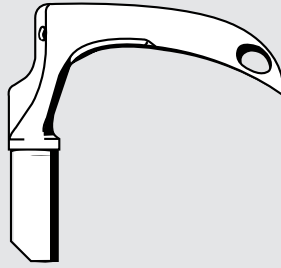

A 8376

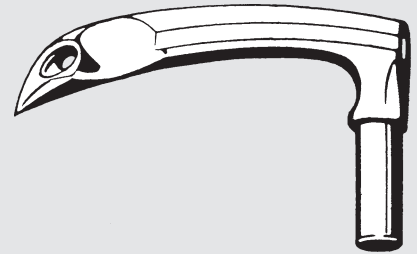

81208

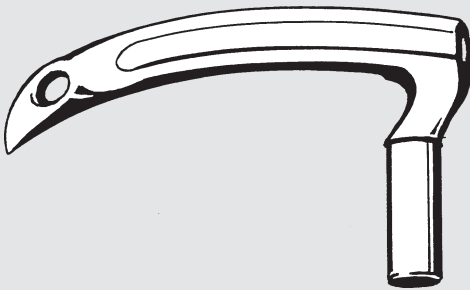

81508



81311 B

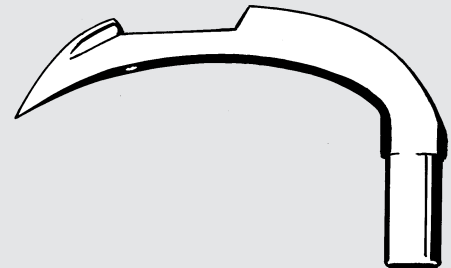

81308 B

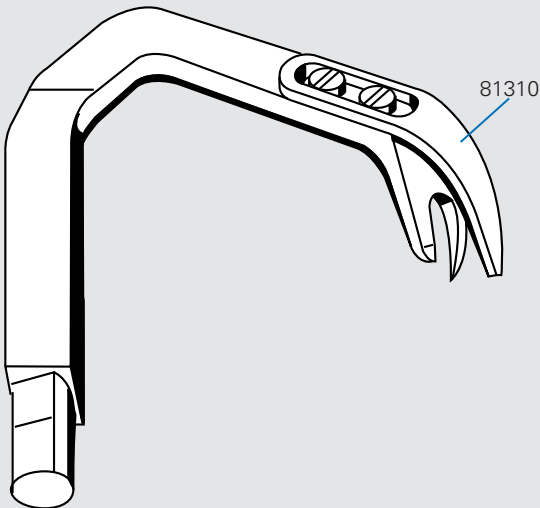

81507

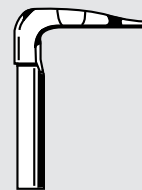

81511

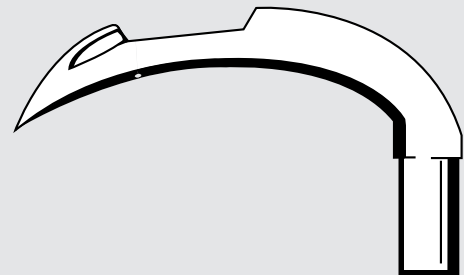

81308 C

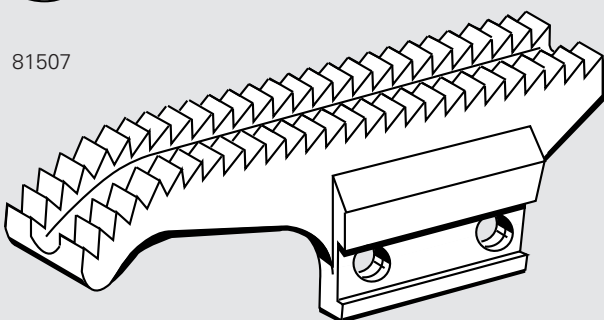

81226 AF

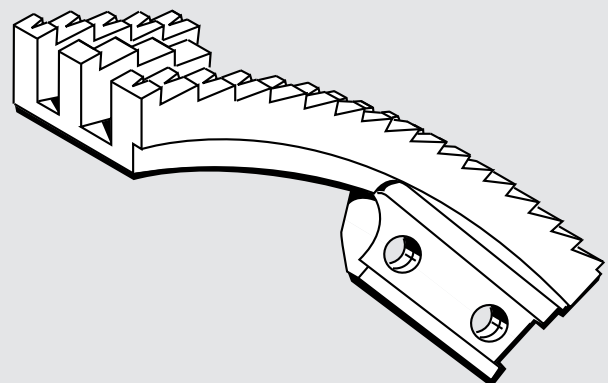

81326



81200, 80200, 80600, 80700  
80800, 81300 A, 81500

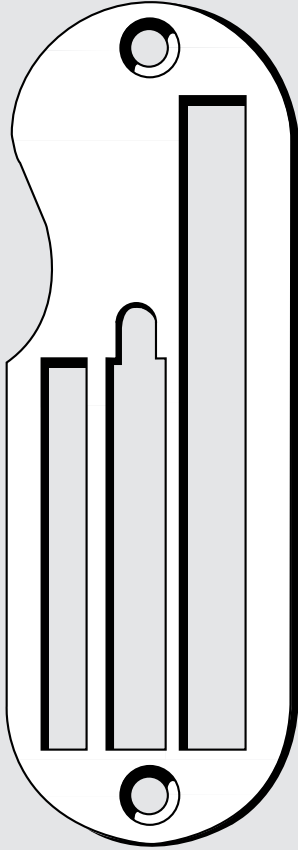

80224

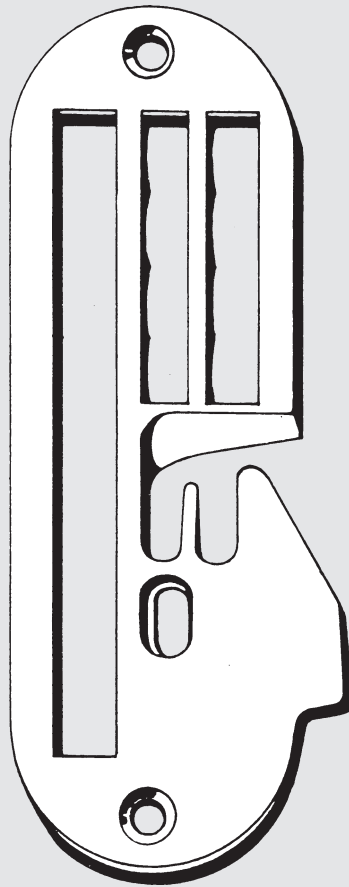

81224 AB

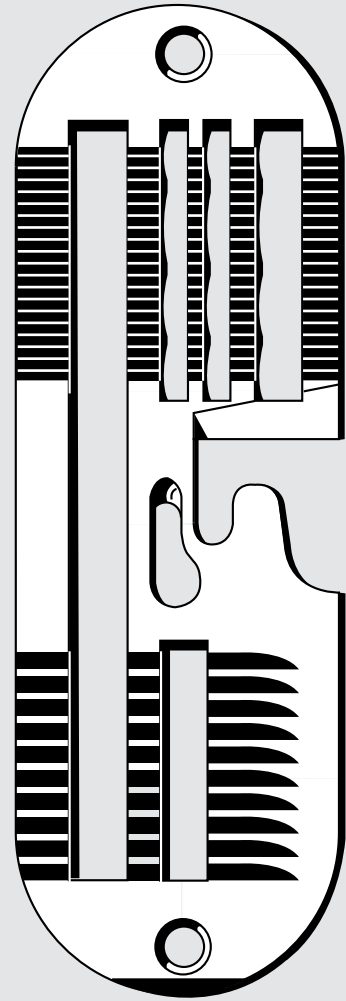

81324 A

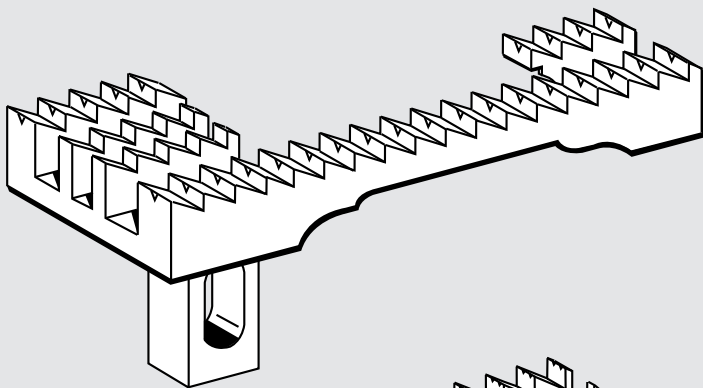

81305 A

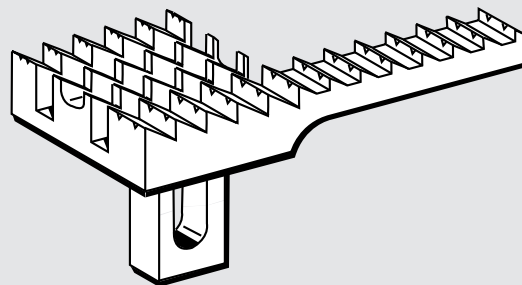

80205

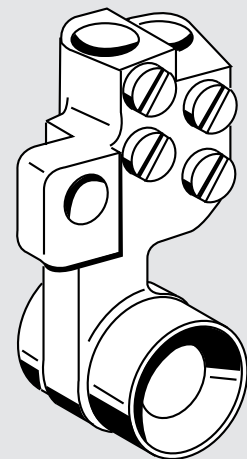

A 8377



## Overlock



1662



1657

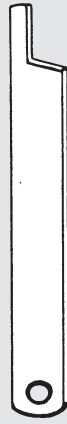

1662 A



1655



5350

## 1301, 1311 Flatlock und Feldlock

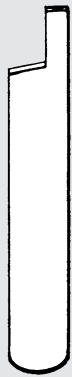

3544 A (HSS)  
312-870-003



CT 3544 A  
312-870-004



3543 (HSS)  
312-870-001



CT 3543  
312-870-002



3018  
312-800-026

**503, 504, 514, 515, 516**  
**E 32, E 52, E 56 etc.**

**siehe Pegasus**  
**see Pegasus**  
**véase Pegasus**



800, 1412 Superlock



D 110-10  
313-870-003  
CT D 110-10



D 119-10  
CT D 119-10



D 110-8 A  
313-870-015  
CT D 110-8 A



D 119-7  
313-870-002  
CT D 119-7

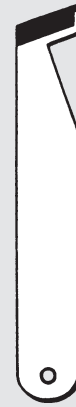

441031 (CT)  
313-870-005 (CT)



442001  
313-810-012

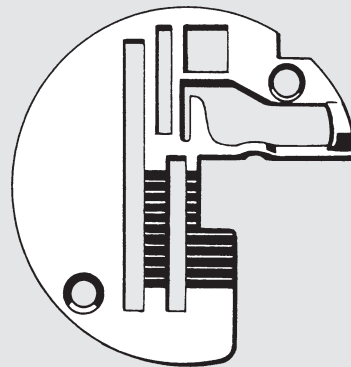

D 250-17 B

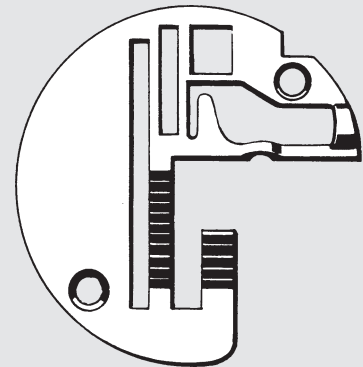

D 250-18 A  
313-801-025



D 60-3  
313-810-010



D 80-4  
313-810-001

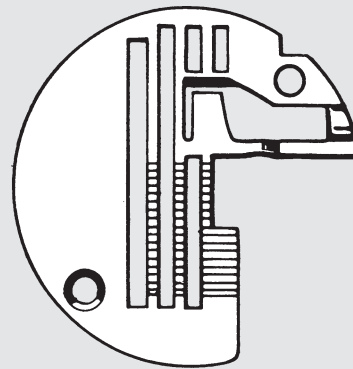

D 250-39  
313-801-036



**DT 30  
VX 2400, 2500**

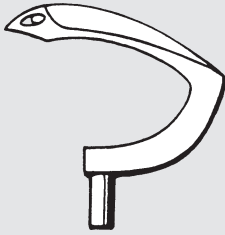

69085



69084

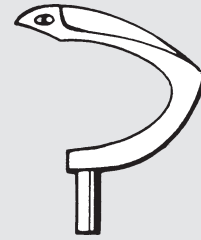

69086

**FD-62 Flatseamer**



68184 SUPER



CT 68184



68121 SUPER

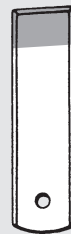

CT 68121

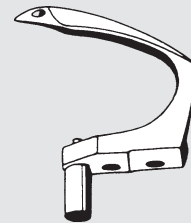

68217



68560

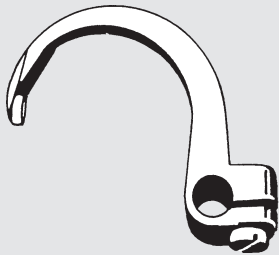

68124

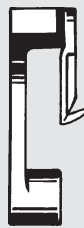

3021092  
68124 SF  
= Kl. FD-62-07 MS

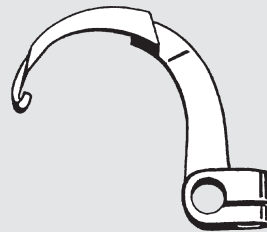

68123

**CB 201-234  
CB 501-544**



85168

**CM-263, CM-268, CM-364  
CM-352, CM-474**



80413

**46, 47**

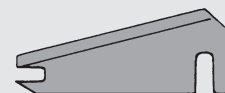

15487 Ceramic





DCZ 203, 220, 222  
DC, DCY, DCZ 221, 331, 341, 428, 520, 521  
Z 830, 831, 833  
Z 610

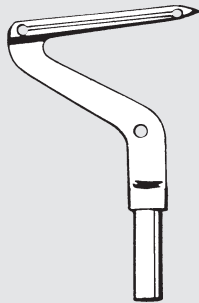

34392  
32790

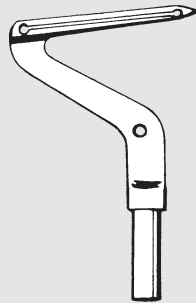

34393  
32415

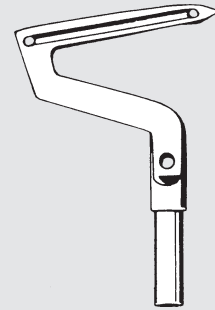

32541

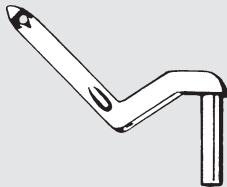

35227  
32539

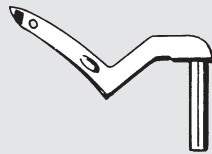

34730  
34599

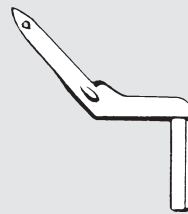

32807

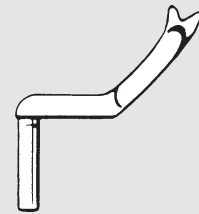

32813



34113

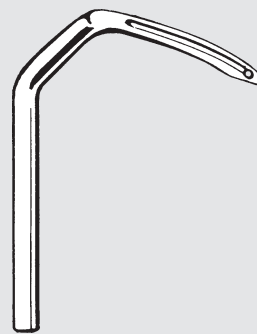

33059

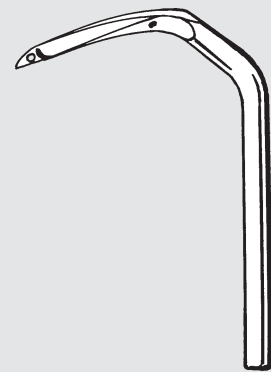

31877

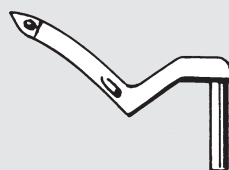

34519

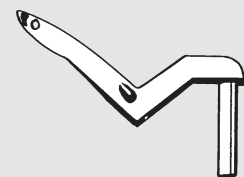

34584



DCZ 203, 220, 222  
DC, DCY, DCZ 221, 331, 341, 428, 520, 521  
Z 830, 831, 833  
Z 610

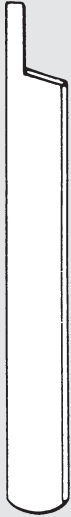

37514



CT 37514



37538

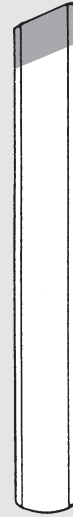

CT 37538

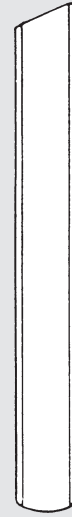

30421

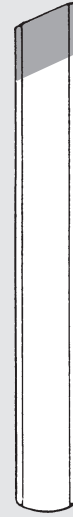

CT 30421



38332



32914 (CT)



35285



CT 35897

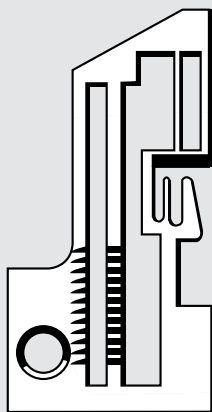

33821



Z 1000, ZF 1000, Z 1500 Series  
Z 2000, Z 3000, Z 5000, Z 6000 Series  
AZ 6000, AZ 8000 Series  
AZF 8000 Series  
AZG 8000 Series  
CZ 6000 Series



CT 20491 G

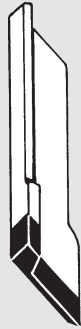

2020003 (CT)

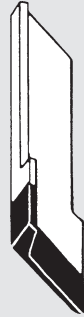

CT 20491



20496 (CT)  
6200022

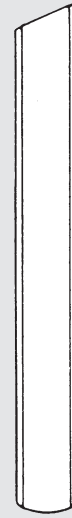

20498



22195



23582



2100167  
6200097

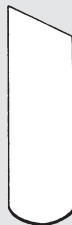

2110305

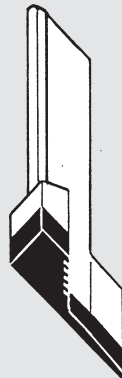

2121107 (CT)



2121111



2101091

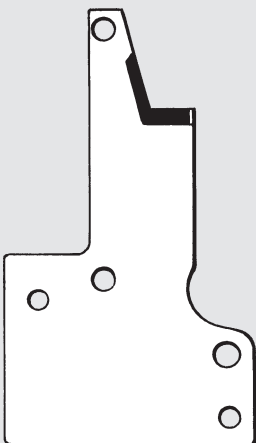

2111055 (CT)

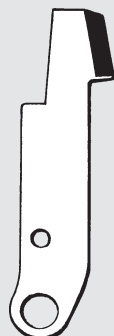

2111056 (CT)



14136  
Kl. ZF 1500



20271



**Z 1000, ZF 1000, Z 1500 Series**  
**Z 2000, Z 3000, Z 5000, Z 6000 Series**  
**AZ 6000, AZ 8000 Series**  
**AZF 8000 Series**  
**AZG 8000 Series**  
**CZ 6000 Series**

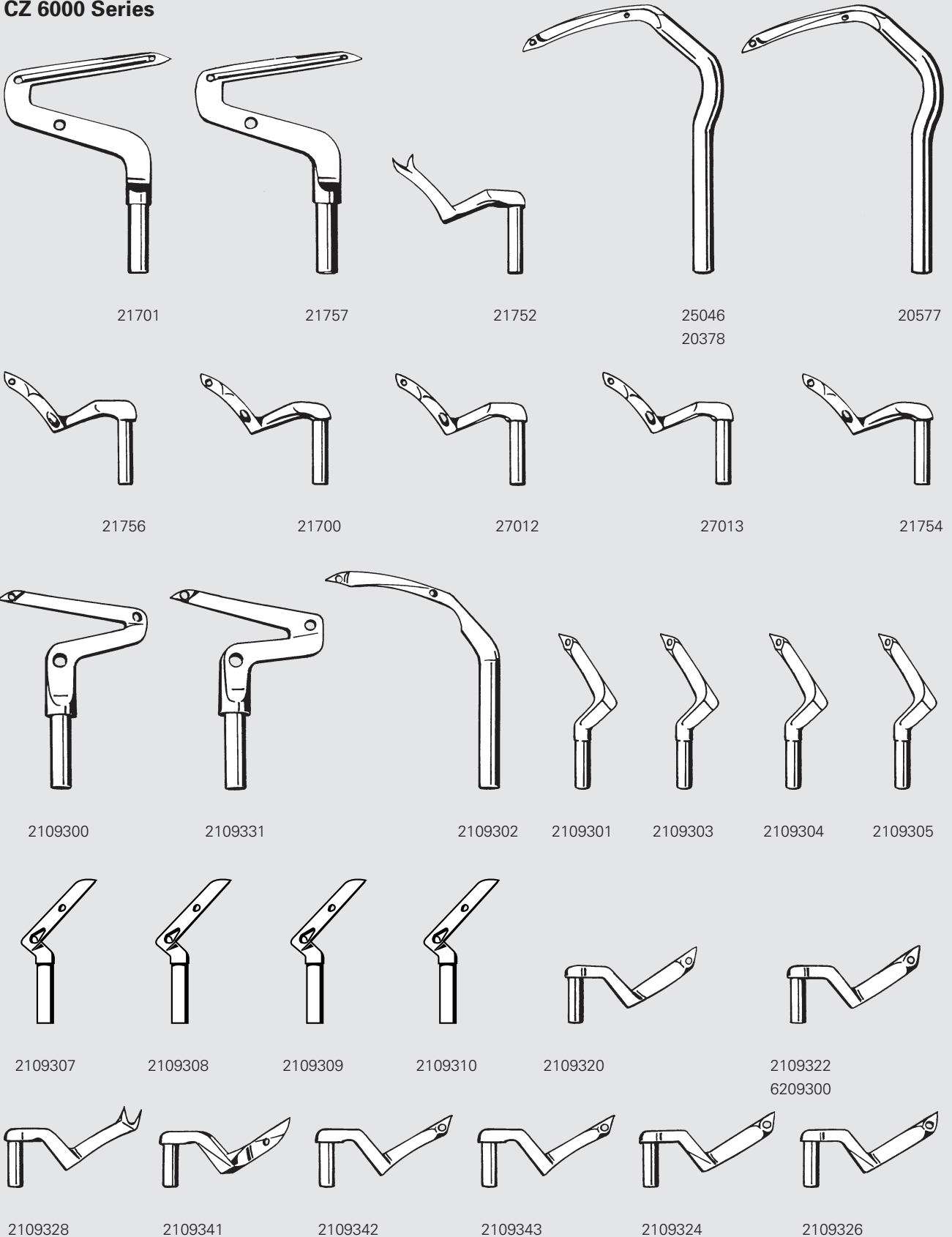



Z 1000, ZF 1000, Z 1500 Series  
Z 2000, Z 3000, Z 5000, Z 6000 Series  
AZ 6000, AZ 8000 Series  
AZF 8000 Series  
AZG 8000 Series  
CZ 6000 Series

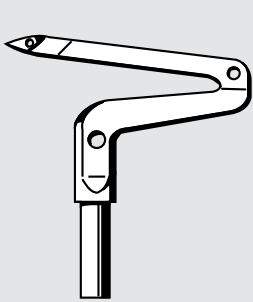

2109334

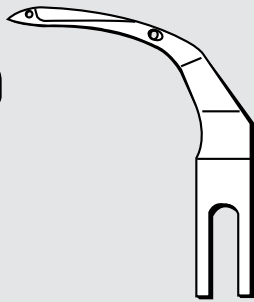

2109335

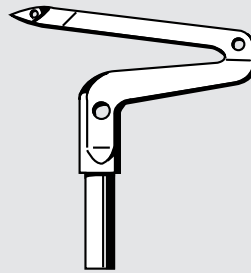

2109347  
6209301

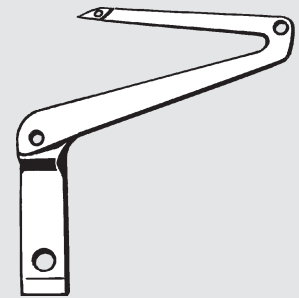

2119305

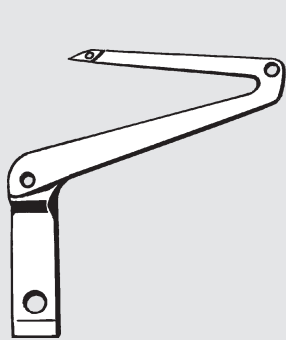

2119324

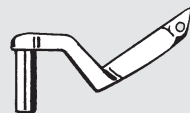

2119322 (F3)

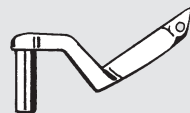

2129300

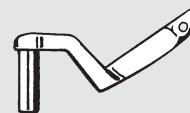

2119301 (Y1)

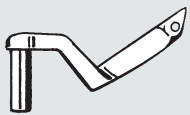

2119323 (F4)

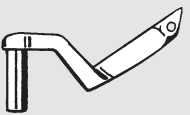

2119302 (Y2)

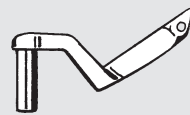

2119303

DW 1802, 1804

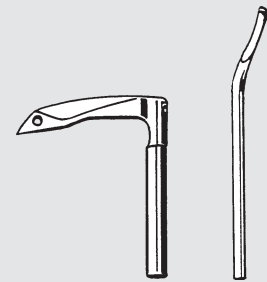

66601 66621

DV 1200, 1400  
DW 1200, 1400



95277

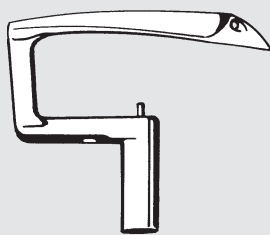

95499

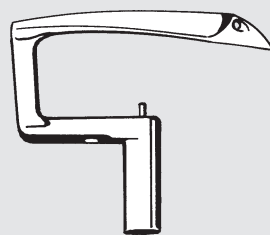

95174  
94480  
93310



94417 (CT)



95399

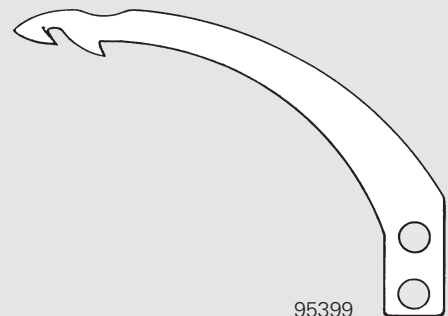



VC 2400, 2600, 2700, 2800, 3600, 3700, 3800  
VE 2700  
VF 2300 M, 2400, 2500, 2800  
VG 2700, 3700  
VGS 2700, 3700

CC 2700, CFZ 2300 M  
MG 2000, VM 1800  
VFS 2500  
VES 2700



95276 (CT)



3201062



3501032 (CT)



3101465 (CT)



3101633



3501200

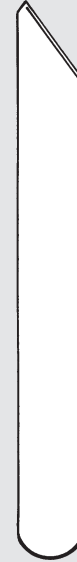

3101607



3101028 (CT)



3101026

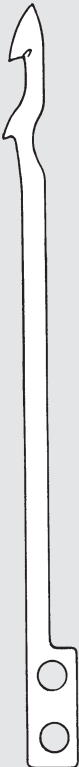

3120151



3120150 (CT)



3100513



3100512

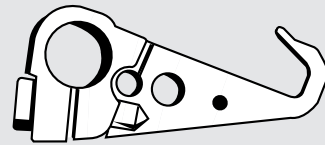

3501534

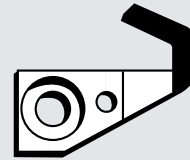

3501535 (CT)

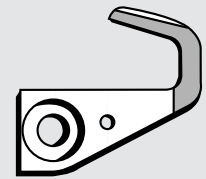

3501597



3110038

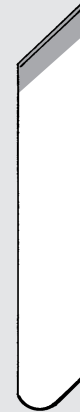

CT 3110038

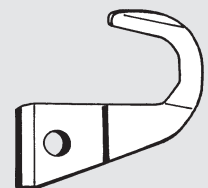

3110037 (CT)



VC 2400, 2600, 2700, 2800, 3600, 3700, 3800  
VE 2700  
VF 2300 M, 2400, 2500, 2800  
VG 2700, 3700  
VGS 2700, 3700

CC 2700, CFZ 2300 M  
MG 2000, VM 1800  
VFS 2500  
VES 2700

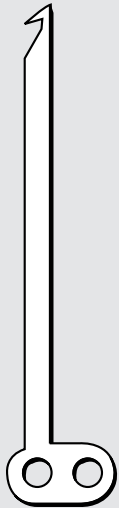

3101801

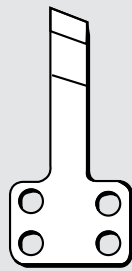

3101802

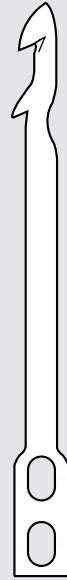

3101699



3101700



3120016

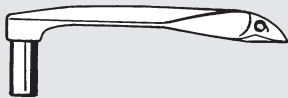

3109300

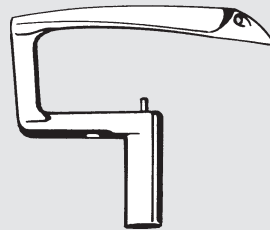

3209311

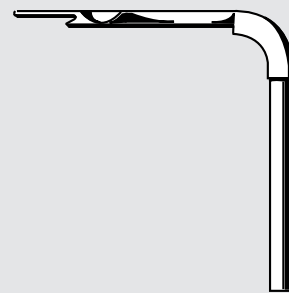

3109310



3109306



**Blindstichnähmaschinen**  
**Blindstitch Sewing Machines**  
**Máquinas de puntada invisible**



Brother  
Kl. CM 2-B931  
Nr. 110121-001



Columbia  
36 C 22-1



Lewis  
36-16  
Kl. 150



US  
3430-22



Strobel  
VLA 48-4  
(18702 Adamson)



Strobel  
1870053



Treasure  
11837 (T 830)



Yamato  
80413

**Barudan**

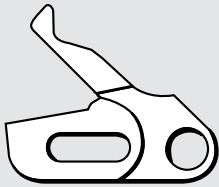

KB 270010

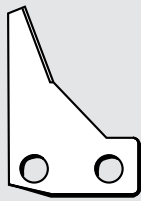

KN 270960



KN 270950  
KN 270951

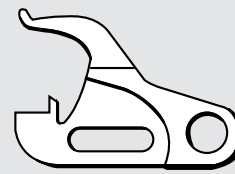

KN 270952



KN 271602  
KN 271980

**Bernina (Bernette)**



50143403 (CT)  
5020101584  
Kl. 334, 335



50145403  
5020101604  
Kl. 334, 335

**British United Shoe Machinery Co.**



KZG 502 E



KZG 757





**Clinton**

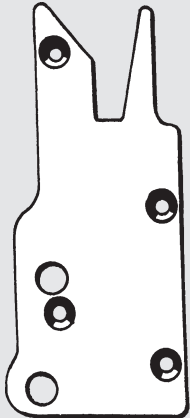

01-4434-01  
für Union 39500/39600  
W & G 504/514

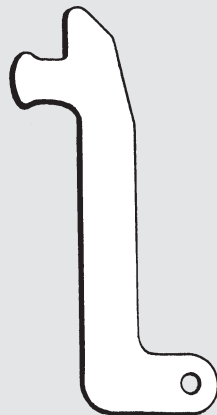

01-4435-01  
für Union 39500/39600  
W & G 504/514

**Gribetz**

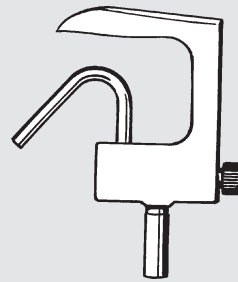

P3-0146 N

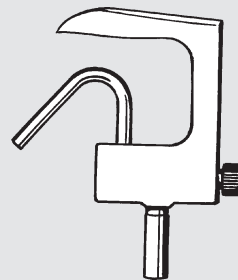

P3-0146

**Meca**

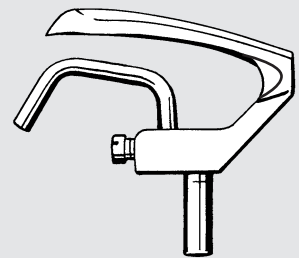

Meca

**Sotco**



Sotco oben  
Nr. 514



Sotco unten  
Nr. 510 S

**Metropolitan**



525 W  
KI. 30-A

**Diamant FR**

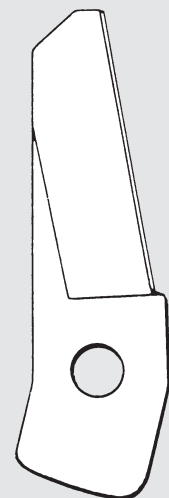

Diamant FR  
CT Diamant FR



### Kettelmaschinen (Kettma, Böttger, Sotco usw.)

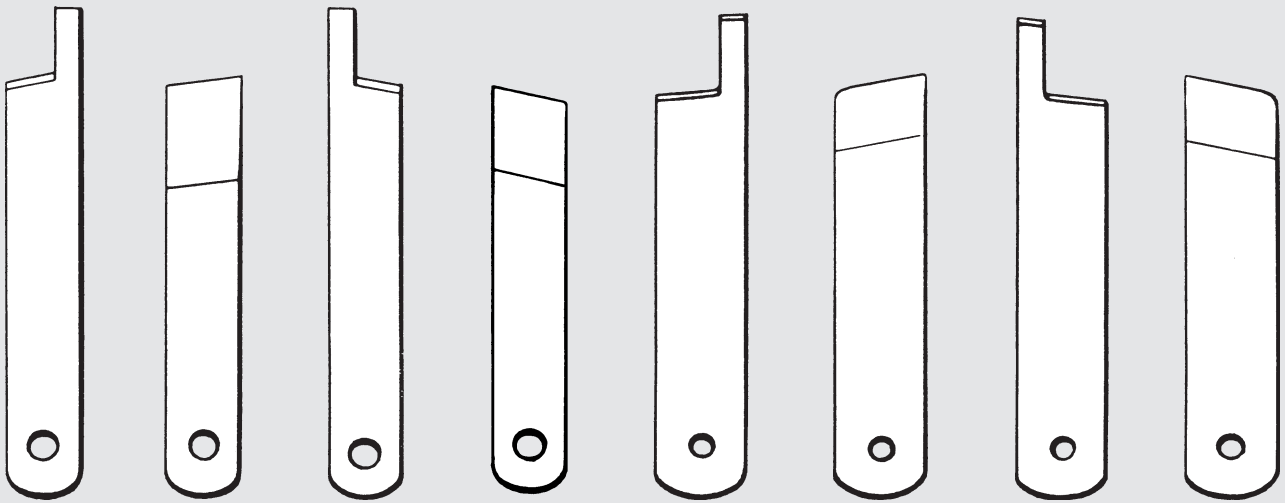

JK-R  
und VB-R  
oben rechts

JK-R  
und VB-R  
unten rechts

JK-L  
und VB-L  
oben links

JK-L  
und VB-L  
unten links

breite Kettelmesser  
rechts oben    rechts unten

breite Kettelmesser  
links oben    links unten

### Titan – Baratto



330 ACAR (CT)

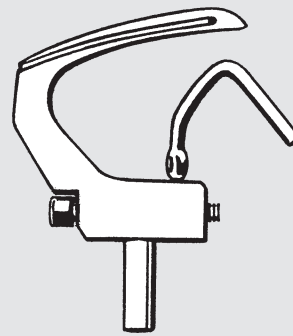

27264

### Tajima

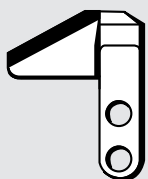

AT 0202 000 000 (CT)

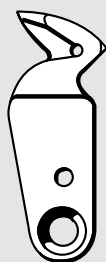

AT 0204 000 000

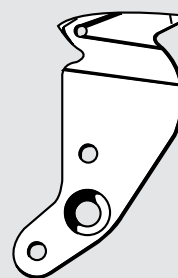

FX 0206 000 000

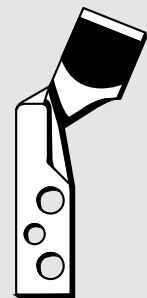

FX 0207 000 000 (CT)



**Pfaff**



29-924993-70/876

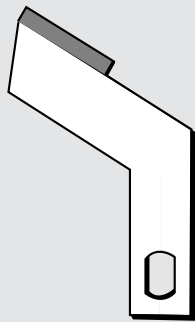

29-924993-70/641

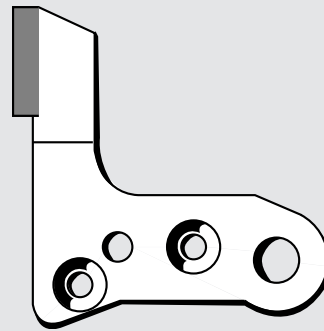

29-924993-81/704

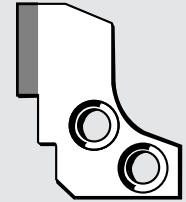

98-788013-00/900



29-924993-81/668



29-924993-71/442



29-924993-81/957

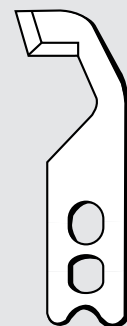

98-784045-02/000

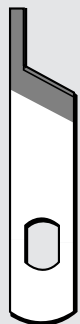

29-924993-56



29-924993-70/299



29-924990-88

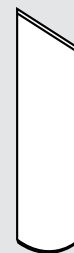

29-924992-56/100

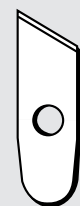

93-415504-49

**Husquarna**

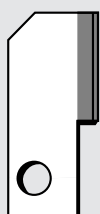

21410042-37



21410042-29

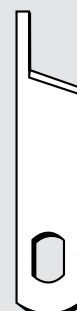

4156597-01



4156628-01



### Juki Babylock



305249

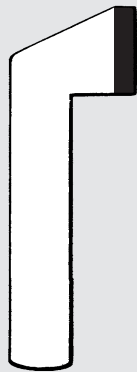

205-9102-01 A (CT)



305248



405-9102-01 A

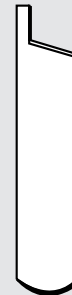

408-9101-01 B



408-9102-01 A



PL-Q11-01 A

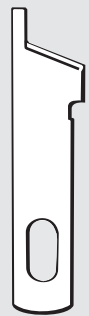

PL-Q11-01 C



PL-R11-01 A



SE-R11-01 A

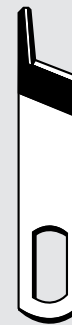

60507 (CT)



60544

### Bernina (Bernette)



50143403 (CT)



50145403

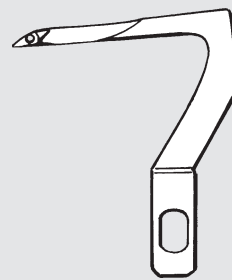

418-6101-02 A



714-6101-01 A

### Singer

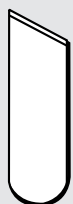

1-412749-000

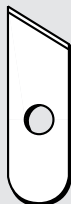

1-550449-000









412585

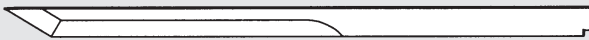

<b>Bullmer</b>		104155	169 x 2,0 x 6 G glatt / smooth / liso
		103630	169 x 2,0 x 6 H hohl / hollow / hueco
		104264	201 x 2,5 x 8 G glatt / smooth / liso
		100124	201 x 2,5 x 8 H hohl / hollow / hueco
		104450	223 x 2,5 x 10 / 8
		104607	223 x 2,5 x 10 / 8 GR glatt / smooth / liso runder Rücken / round back / lomo redondeado
		105935	223 x 2,5 x 10 / 8 K kurzer Schnitt / short cut / corte corto
		103986	223 x 2,5 x 8 G glatt / smooth / liso
		102642	223 x 2,5 x 8 H hohl / hollow / hueco
	<b>F.K.</b>		
<b>Gerber</b>		095581300	128 x 0,9 x 5
		G 93	175 x 1,5 x 6,3
		G 93 HPC / S 5200 1100880 / 054782004	195 x 2,0 x 7,9
		G 3000 / 3200 PN 07338700	202 x 2,1 x 6,3
		085878000 GTXL	206 x 1,9 x 7,9 / 6,4
		G 91 / G 93 / Z7 S 7200 / S 7500	254 x 2,35 x 8 Bohrung / hole / taladro
		G91 / S 93 / Z7 S 7200 / S 7500 02126109	254 x 2,35 x 8 Schlitz / slot / hendidura
		032419013	254 x 3,13 x 9,7 Heavy duty
<b>Wastema</b>		WA 16	256 x 2,0 x 8



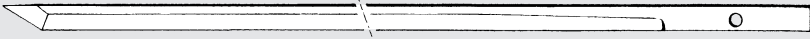





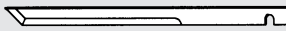
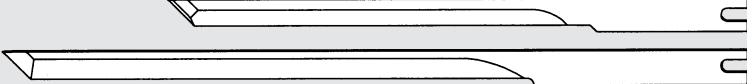
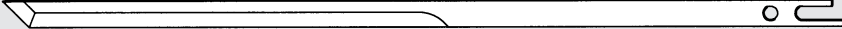
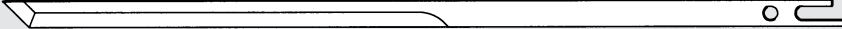

**Investronica**

	CV 2	45,5 x 1,5 x 6,5
	SC 4 DIS, S 40 81700300	187 x 1,95 x 8
	S 70817001301	245 x 2,52 x 8,3 / 7,8
	S 70817001 E 02	245 x 3,0 x 8,3 / 7,8
	SC 2	252 x 2,5 x 7,8 / 8,3
	SC 2	291 x 2,52 x 7,85
	SC 2	296 x 2,52 x 8 K kurzer Schnitt / short cut / corte corto

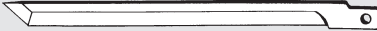
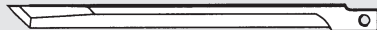







**Kuris**

	ZAT 3 Nr. 24306	84 x 1,0 x 5
	TexCut Nr. 47968	178 x 2,5 x 10
	WA 16	227 x 3,0 x 10,5 / 9,0
	WA 16	256 x 2,0 x 8

**Lectra**

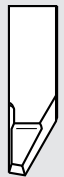
	Vector 2500	89 x 1,5 x 5,5
		89 x 1,5 x 5,5 / 3,5
	System 95	113 x 2,0 x 7,5 / 6
	System 95	113 x 2,0 x 7,5 / 6 H hohl / hollow / hueco
	System 95 Vector 500 / 5000	296 x 2,0 x 7
	System 95	296 x 3,0 x 8,5 / 6,5
		296 x 3,0 x 7
	116802 Vector 7000	360 x 2,4 x 7
	System 96 Vector 7000	360 x 3,0 x 8,5

**Diverse Vollhartmetall Messer / Knives solid carbide / Cuchillas metal solide duro**

								
107506 T Bullmer	TL055 Gerber	F0495H Lectra	01039999 Atom	HZ3B Comelz	HZ5K.S Comelz	Z41 Zünd	Z42 Zünd	Z43 Zünd



**Hoogs**



**Kuris /  
Maimin  
Suprena**



**Bullmer**

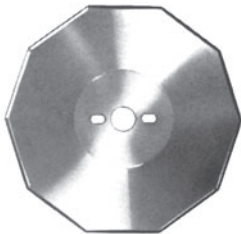

**Bullmer**

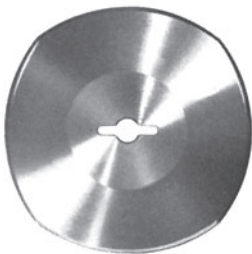

**Hoogs**

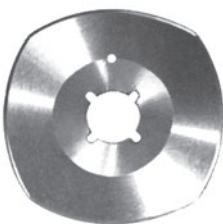

**Kuris /  
Suprena**

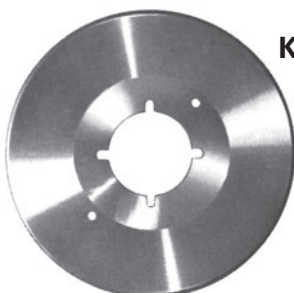

**Kuris**

Für Fabrikat For Machines Para producto	Messerform Shape of knives Forma de la cuchilla	Außen Ø Outer dia. Diámetro exterior	Bohrung Hole Espesor	Stärke Thickness Taladro
Type		mm	mm	mm

**Bullmer**

602	für 0250/1	10-kant	-sided	-cantos	50	14x8x2,5	1,0
604, 801	für 0470/1	10-kant	-sided	-cantos	59	10	1,0
601, 605	für 0570/1	10-kant	-sided	-cantos	79	10	2,0
607	für 0674/1	rund	round	circulares	100	10	1,5
606, 607, AV 300	für 0670/1	10-kant	-sided	-cantos	100	10	2,0
	für 675/1	4-Bogen	-curves	-arcos	100	10	2,0
	für 970	4-Bogen	-curves	-arcos	110	15	1,5
608, 609	für 840R	rund	round	circulares	126	45	1,0
	für 870/1	10-kant	-sided	-cantos	126	45	1,0

**Hoogs**

Piccolo, Liliput, Favorit	MS-1	rund	round	circulares	50	25x10x4	1,2
Piccolo, Liliput, Favorit	MS-3	10-kant	-sided	-cantos	50	25x10x4	1,2
Piccolo, Liliput, Favorit	MS-2	4-Bogen	-curves	-arcos	50	25x10x4	1,2
Piccolo, Liliput, Favorit	MS-55	7-Bogen	-curves	-arcos	50	25x10x4	1,2
IAK, IAG, Goliath	MS-10	rund	round	circulares	60	25x10x4	1,2
IAK, IAG, Goliath	MS-11	4-Bogen	-curves	-arcos	60	25x10x4	1,2
IAK, IAG, Goliath	MS-12	10-Kant	-sided	-cantos	60	25x10x4	1,2
Z+St	MS-20	rund	round	circulares	110	25x10x4	1,5
Z+St	MS-21	4-Bogen	-curves	-arcos	110	25x10x4	1,5
Z+St	MS-22	10-Kant	-sided	-cantos	110	25x10x4	1,5
X-130, X-130-N	MS-28	rund	round	circulares	130	25x10x4	1,5
X-130, X-130-N	MS-29	4-Bogen	-curves	-arcos	130	25x10x4	1,5
X-130, X-130-N	MS-30	10-Kant	-sided	-cantos	130	25x10x4	1,5

UM-6



501-135-UM 6  
Klasse ST 2000 / 5000

UM-5



501-138-UM-5 Klasse ST-1  
200-130-UM-5 Klasse ZN-ZVN  
512-110-UM-5 Klasse ST 565

**Kuris**

Novita	15780	rund	round	circulares	50	16	1,0
Novita	16110	6-Bogen	-curves	-arcos	50	16	1,0
Novita	16120	8-Bogen	-curves	-arcos	50	16	1,0
Supernovita		rund	round	circulares	57	16	1,0
Supernovita		6-Bogen	-curves	-arcos	57	16	1,0
BOM 60	15752	rund	round	circulares	60	22	1,0
BOM 60	16000	4-Bogen	-curves	-arcos	60	22	1,0
BOM 30/80	15762	rund	round	circulares	80	22	1,0
BOM 30/80	16012	4-Bogen	-curves	-arcos	80	22	1,0
BOM 30/80	16092	6-Bogen	-curves	-arcos	80	22	1,0
BOM 30/80	16162	8-Bogen	-curves	-arcos	80	22	1,0
BOM 100/101	15772	rund	round	circulares	100	22	1,0
BOM 100/101	16022	4-Bogen	-curves	-arcos	100	22	1,0
BOM 100/101	16102	6-Bogen	-curves	-arcos	100	22	1,0
KRH 10	15712	rund	round	circulares	100	35	1,2
KRH 10	16042	4-Bogen	-curves	-arcos	100	35	1,2
KRH 12, KRT 120	15722	rund	round	circulares	120	35	1,2
KRH 12	16052	4-Bogen	-curves	-arcos	120	35	1,2
KRH 15	15732	rund	round	circulares	150	35	1,6
KRH 15	16062	4-Bogen	-curves	-arcos	150	35	1,6
KRH 20	15742	rund	round	circulares	200	40	2,2
KRH 20	16172	4-Bogen	-curves	-arcos	200	40	2,2
Champion CRA	15802	rund	round	circulares	100	8	1,3



25 208 (CT)  
Suprena M 460 / 706



30 785 (CT)  
Suprena M 456, M 458

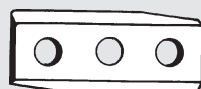

02 257



31 391 (CT)



22 219 (CT)



### Eastman



### Maimin

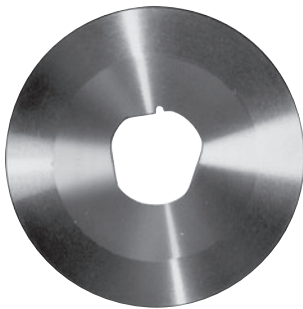

### Wolf

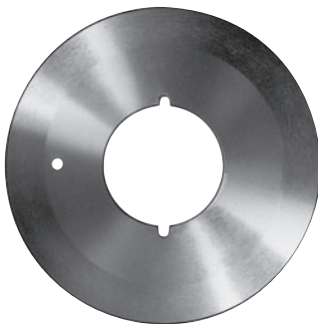

### Razor



Für Fabrikat For Machines Para producto	Messerform Shape of knives Forma de la cuchilla	Außen Ø Outer dia. Diámetro exterior	Bohrung Hole Espesor	Stärke Thickness Taladro
Type		mm	mm	mm
<b>Eastman</b>				
080 C 01-				
123 2 1/2"	Buzzaird 4-Bogen -curves	-arcos 48,8	16	
147 2 1/4"	Chickadee rund round	circulares 57	16	
26 3 1/2"				
59 4"	Falcon IV, Track, Robin rund round	circulares 90	28	
101 5"	rund round	circulares 101,6	40	
61 5 1/4"	548/355-61 rund round	circulares 127	51	
	5 1/2" rund round	circulares 133,6	51	
39 6"	548/562/567 rund round	circulares 140	51	
		152,6	51	
<b>Maimin</b>				
Minishear 2"	rund round	circulares 50	16	
Minishear 2"	6-Bogen -curves	-arcos 50	16	
Minishear 2"	8-Bogen -curves	-arcos 50	16	
ACD 2 1/2"	rund round	circulares 63,3	21,6	1,0
ACDC 4"	rund round	circulares 102	40	1,0
ACDC 5"	rund round	circulares 127	40	1,2
ACDC 5 1/4"	rund round	circulares 133,5	51,8	1,3
ACDC 6"	rund round	circulares 152,5	58,2	1,4
ACDC 7"	rund round	circulares 178		
<b>Suprena</b>				
M702	rund round	circulares 50	16	
M700	6-Bogen -curves	-arcos 50	16	
M703	8-Bogen -curves	-arcos 50	16	
R742	rund round	circulares 80	22	
R740	8-Bogen -curves	-arcos 80	22	
R1512	rund round	circulares 100	22	
R1514	4-Bogen -curves	-arcos 100	22	
R1513	6-Bogen -curves	-arcos 100	22	
<b>Wolf</b>				
PUP 25260	4-Bogen -curves	-arcos 52,5	17,6	1,0
SRN 2 1/2"	rund round	circulares 64		1,0
Clipper 4"	23 einfasig rund round	circulares 102	31,75	1,0
Clipper 4"	23 zweifasig rund round	circulares 102	31,75	1,0
Clipper 4 3/4"	22 rund round	circulares 121	42,5	1,0
Blazer 5 1/4"	21 rund round	circulares 134	42,5	1,0
SLIM JIM 5 1/4"	24 rund round	circulares 134	50	1,0
Blazer 6"	16 rund round	circulares 153	40	1,2
Blazer-0 6"	18 rund round	circulares 153	50,8	1,2
Blazer 7"	rund round	circulares 178	50,8	1,4
Blazer-0 8"	rund round	circulares 203	50,8	1,4
BIG-0 10"	rund round	circulares 254	50,8	1,7
<b>Diverse</b>				
Allstar 100 AS-1026	6-Bogen -curves	-arcos 50	12,7	
KM RS 100	rund round	circulares 100	21	
KM RS 100 OCTA	8-Bogen -curves	-arcos 100	21	
Razor Extra 86 C	rund round	circulares 86	22,4	
Razor Extra D 100 C	rund round	circulares 100	22,4	
Razor Extra D 100 S	4-Bogen -curves	-arcos 100	22,4	
SULEE Modell 260	=Hoogs Z+St rund round	circulares 110		
Miniroller	4-Bogen -curves	-arcos 100	25x10x5	
Tuffy HSS	4-Bogen -curves	-arcos 65,6		1,2

**Weitere Kreismesser fertigen wir nach Muster oder Zeichnung**  
**We produce further knives according to sample or drawing**  
**Producimos más cuchillas circulares según muestra o dibujo**







**Alle Messer sind auch in HSS verfügbar**  
**All knives are available in High-Speed-Steel**  
**Todos las cuchillas tambien en acero rápido de alto rendimiento**



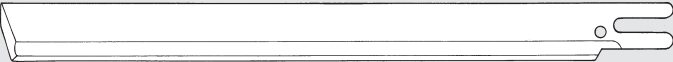
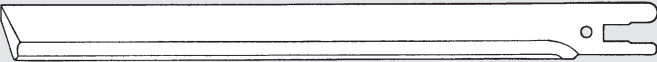
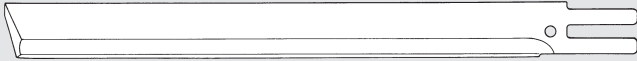

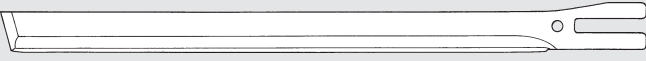
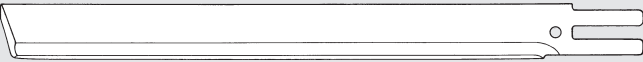
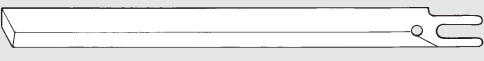
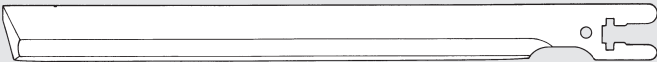
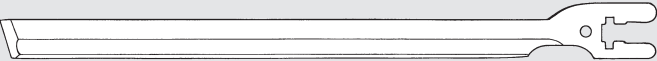
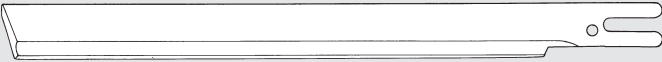
**HSS-Stahl • High-Speed-Steel • Acero rápido de alto rendimiento**

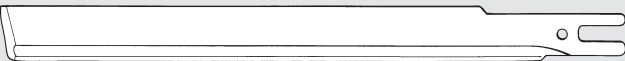
Abmessungen / Sizes /  
Dimensiones:

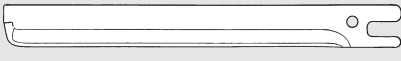
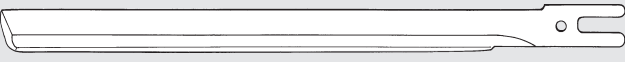
	<b>Beaver/Bullmer</b>	5", 6", 7", 8", 9" 10", 11,5", 13", 14"
	<b>Comet/Gury</b>	4", 5", 6", 7", 8", 9" 10", 11,5", 13", 14"
	<b>Eastman Suprena</b>	4", 5", 6", 7", 8", 9" 10", 11,5", 13", 14" 8" S 0335, 10" S 0352
	<b>Eastman Servo Cutter 16,5</b>	6", 8", 10" gerade geschliffen = 16,5 mm ground straight at the back = 16,5 mm Lomo afilado recto = 16,5 mm
	<b>Eastman Servo Cutter 14,3</b>	6", 8", 9", 10" ausgeschliffen = 14,3 mm ground off at the back = 14,3 mm Lomo rectificado = 14,3 mm
	<b>KM/Hoogs KS-AU</b>	5", 6", 7", 8", 9", 10", 11,5", 13"
	<b>KM Automatik KS-EU</b>	5", 6"
	<b>Maimin</b>	5", 6", 7", 8", 9" 10", 11,5", 13", 14"
	<b>Maimin Servo Cutter</b>	5", 6", 7", 8"
	<b>Wolf</b>	5", 6", 7", 8", 9", 10", 11,5", 13"
	<b>Kuris-KV</b>	KVW 70 / 4" 15056 KV 90 / KVW 12 / 5" 15105 KV 115 / KVW 15 / 6" 15155 KV 140 / KVW 18 / 7" 15205 KVW 20 / 8" 15256 KV 200 / 10" 15305
	<b>Kuris-KV 4</b>	KV 1100 / 6" 15383 KV 1350 / 7" 15382 KV 1600 / 8" 15380 KV 2000 / 10" 15381
	<b>Kuris</b>	KVS 700 15376
	<b>Kuris</b>	KVS 900 15389
	<b>Kuris Servo Cutter</b>	SC 700 / 4" 15388 SC 900 / 5" 14237 SC 1100 / 6" 14637 SC 1350 / 7" 14637 SC 1600 / 8" 14638 SC 2000 / 10" 17627

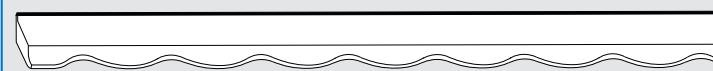

**Sämtliche Messer auch konvex/gewellt verfügbar  
All knives are also available as: convex/wavy  
Todos las cuchillas también como edición convexo**



Für alle Bandmesser-Zuschneidemaschinen  
z.B. Kuris, Hoogs, Bullmer, Wastema, Hitaka,  
CKS, NCA, Takaoka usw.  
10–20 mm breit,  
0,45 mm stark,  
in verschiedenen Schlifffarten  
(siehe unten).

For all band knife cutting machines, e.g.  
Kuris, Hoogs, Bullmer, Wastema, Hitaka,  
CKS, NCA, Takaoka etc.  
10–20 mm wide  
0,45 mm thick  
in various grinding versions  
(see below).

Para todas las máquinas cortadoras  
de cuchilla cinta p.e. Kuris, Hoogs, Bullmer,  
Wastema, Hitaka, CKS, NCA, Takaoka etc.  
Ancho 10–20 mm,  
espesor 0,45 mm  
varios afilados  
(véase abajo).

Hergestellt aus erstklassigem Material,  
lieferbar als Meterware oder in Endloslängen  
(Fixlängen).

Manufactured of first-class material,  
available in metrages or endless length  
(fix length)

Hechas de materiales de primera clase, de  
ser entragadas por metro o en largos conti-  
nuos (largos fijos).

glatt  
smooth  
liso

gezahnt  
serrated  
dentado

gezahnt 2,5 mm  
serrated 2,5 mm  
dentado 2,5 mm

konkav  
concave  
cóncavo

konvex  
convex  
convexo

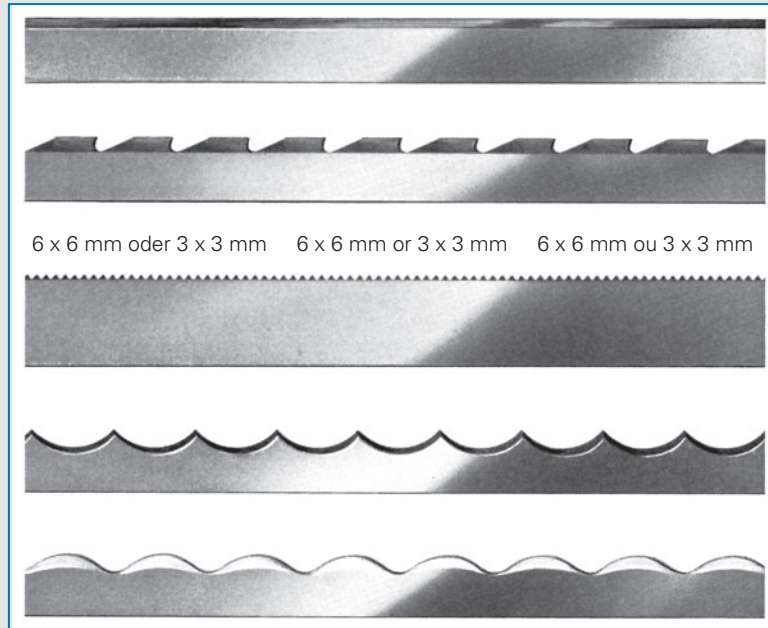

Einseitige Wate  
Single bevel  
Biselado unilateral



Doppelte Wate  
Double bevel  
Biselado doble



Vierfach Wate  
Four bevels  
Biselado cuádruplo

Gebräuchliche Abmessungen: glatt, doppelte Wate  
Usual dimensions: smooth, double bevel  
Dimensiones en uso: liso, biselado doble

2400 x 10 x 0.45	3605 x 10 x 0.45	4200 x 10 x 0.45	4810 x 10 x 0.45
2430 x 10 x 0.45	3680 x 10 x 0.45	4210 x 10 x 0.45	4850 x 10 x 0.45
2450 x 10 x 0.45	3700 x 10 x 0.45	4210 x 15 x 0.45	4850 x 15 x 0.45
2880 x 10 x 0.45	3720 x 10 x 0.45	4240 x 10 x 0.45	4900 x 10 x 0.45
2900 x 10 x 0.45	3750 x 10 x 0.45	4250 x 10 x 0.45	4920 x 10 x 0.45
2945 x 10 x 0.45	3760 x 10 x 0.45	4350 x 10 x 0.45	4920 x 15 x 0.45
3000 x 10 x 0.45	3840 x 10 x 0.45	4400 x 10 x 0.45	5030 x 10 x 0.45
3050 x 10 x 0.45	3850 x 10 x 0.45	4450 x 10 x 0.45	5050 x 10 x 0.45
3100 x 10 x 0.45	3860 x 10 x 0.45	4460 x 10 x 0.45	5070 x 10 x 0.45
3100 x 15 x 0.45	3870 x 10 x 0.45	4500 x 10 x 0.45	5150 x 10 x 0.45
3120 x 10 x 0.45	3880 x 10 x 0.45	4530 x 10 x 0.45	5200 x 10 x 0.45
3150 x 10 x 0.45	3900 x 10 x 0.45	4550 x 10 x 0.45	5207 x 12 x 0.45
3240 x 10 x 0.45	3900 x 15 x 0.45	4550 x 15 x 0.45	5210 x 10 x 0.45
3300 x 10 x 0.45	3950 x 10 x 0.45	4555 x 10 x 0.45	5230 x 10 x 0.45
3360 x 10 x 0.45	3960 x 10 x 0.45	4560 x 10 x 0.45	5270 x 10 x 0.45
3380 x 10 x 0.45	4020 x 10 x 0.45	4600 x 10 x 0.45	5280 x 10 x 0.45
3400 x 10 x 0.45	4040 x 10 x 0.45	4620 x 10 x 0.45	5285 x 10 x 0.45
3420 x 10 x 0.45	4050 x 10 x 0.45	4650 x 10 x 0.45	5300 x 10 x 0.45
3460 x 10 x 0.45	4080 x 10 x 0.45	4690 x 10 x 0.45	5300 x 12 x 0.45
3470 x 10 x 0.45	4094 x 10 x 0.45	4700 x 10 x 0.45	5300 x 15 x 0.45
3480 x 10 x 0.45	4100 x 10 x 0.45	4745 x 10 x 0.45	5500 x 10 x 0.45
3500 x 10 x 0.45	4100 x 12 x 0.45	4750 x 10 x 0.45	5800 x 15 x 0.45
3530 x 10 x 0.45	4115 x 12 x 0.45	4750 x 12 x 0.45	5840 x 10 x 0.45
3540 x 10 x 0.45	4120 x 10 x 0.45	4750 x 15 x 0.45	6040 x 10 x 0.45
3550 x 10 x 0.45	4130 x 10 x 0.45	4800 x 10 x 0.45	
3600 x 10 x 0.45	4150 x 10 x 0.45	4800 x 15 x 0.45	



## Die Schmirkelschnur ist: Features of the abrasive cord:

- flexibel / flexible
- abriebfest / resistant to abrasion
- verschleißarm / wear resisting
- geruchsneutral / odourless
- bruchfest / break-proof
- gleichmäßig im Durchmesser  
constant diameter

			Abrasive cords Standard Schmirkelschnur Standard cord		Silicon Carbide cords Feinere Struktur finer structure		Polisher cords zum Polieren for polishing		Oxyd Polisher cords zum Feinstpolieren for finest polishing	
Ø mm	Ø Zoll/Inch		Bestell-Nr. Order No.	Körnung Grain	Bestell-Nr. Order No.	Körnung Grain	Bestell-Nr. Order No.	Körnung Grain	Bestell-Nr. Order No.	Körnung Grain
<b>Rollen/Spools 15 m:</b>										
66	0,3	0,012			1SC/15	280	1PC/15	280		
60	0,4	0,015	2AC/15	280	2SC/15	280	2PC/15	280		
55	0,5	0,019	3AC/15	240	3SC/15	240	3PC/15	280	3OX/15	Oxyd
54HS	0,6	0,023	4AC/15	240	4SC/15	240	4PC/15	280	4OX/15	Oxyd
	0,7	0,027	5AC/15	240	5SC/15	240	5PC/15	280	5OX/15	Oxyd
54	0,8	0,031	7AC/15	180	7SC/15	180	7PC/15	280	7OX/15	Oxyd
53	1,0	0,039	8AC/15	180	8SC/15	180	8PC/15	280	8OX/15	Oxyd
	1,2	0,047	12AC/15	150	12SC/15	150	12PC/15	280	12OX/15	Oxyd
52/51	1,4	0,055	14AC/15	150	14SC/15	150	14PC/15	280	14OX/15	Oxyd
50	1,8	0,071	18AC/15	120	18SC/15	120	18PC/15	280	18OX/15	Oxyd
49	2,1	0,082	21AC/15	120	21SC/15	120	21PC/15	280		

### Rollen/Spools 50 m: (1,4 und 1,8 mm Ø = 25 m)

66	0,3	0,012			1SC/50	280				
60	0,4	0,015	2AC/50	280	2SC/50	280	2PC/50	280		
55	0,5	0,019	3AC/50	240	3SC/50	240	3PC/50	280		
54HS	0,6	0,023	4AC/50	240			4PC/50	280		
	0,7	0,027	5AC/50	240			5PC/50	280		
54	0,8	0,031	7AC/50	180	7SC/50	180	7PC/50	280		
53	1,0	0,039	8AC/50	180	8SC/50	180				
	1,2	0,047	12AC/50	150						
52/51	1,4	0,055	14AC/25	150						
50	1,8	0,071								

### Rollen/Spools 15 m Abrasive Tapes (Band):

Breite/ width mm		inch		M/Nr.		Bestell- Order-No.		Breite/ width mm		inch		M/Nr.		Bestell- Order No.	
1,6		3/32		01		16AT/15		3,2		4/32		57		32AT/15	
								4,8		6/32		58		48AT/15	
2,5		3/32		56		25AT/15		6,0		8/32		59		60AT/15	